

2007-2012

WRANGLER CATALOG

PERFORMANCE PARTS - ACCESSORIES - REPLACEMENT PARTS



OWN A JEEP?

The toughest four letter word on wheels. Are you looking for a parts source rugged enough to match your off the beaten path sense of adventure? With more than 15,000 unique part numbers from brands like Omix-ADA®, Rugged Ridge®, Alloy USA®, Outland Automotive®, ORV™ Suspension and Precision Gear®, consider this your trail guide to the 4x4 of your dreams. A go anywhere, anytime, in any weather vehicle. Go ahead and smile, because it's going to take a lot of courage not to be cocky when you own a Jeep® like that.



WHO WE ARE

Omix-ADA, Inc.® is more than just a parts manufacturer, we're a community of enthusiasts dedicated to producing the finest in off road solutions. Our products have been propelling four-wheel drive vehicles down highways, back roads and over the world's roughest terrain for over a decade. Omix-ADA's® team of engineers have developed, tested and trail ridden thousands of new products until they were perfected for you.

AWARD WINNING DESIGNS

More than 2,500 new products are displayed at the SEMA Show every year. Groups of journalists and industry experts are charged with the task of judging the most innovative new products introduced into the automotive industry. Omix-ADA® emerged as one of the most decorated companies in the off road sector, and has won numerous awards over the years. The legacy still continues.

LICENSED PARTS

Why have we put so much time and energy into developing the most expansive collection of Jeep® parts available under one roof? Because the items bearing our logo are more than just parts, they are built with a legacy and heritage in mind. This is why we have been authorized to use the "MOPAR Authentic Restoration" and "MOPAR Official Licensed Product" logos for the more than 30 licensed parts we produce. We take pride in being one of the few manufacturers strong enough to stand behind the legendary Jeep® name.

THE OMIX-ADA® BRANDS



OMIX-ADA, Inc.

Omix-ADA, Inc.®
omix-ada.com

The parent company brand that offers thousands of parts and components for all Jeep® vehicles built from 1941 to current!



Rugged Ridge®
ruggedridge.com

Featuring the most complete line of high quality and functional accessories for your Jeep® vehicle.



Alloy USA®
alloyusa.com

A full line of the highest quality, high performance off road and racing alloy axles, and ring & pinions.



Outland®
outlandautomotive.com

Offering a full line of truck/SUV tube steps, bull bars, consoles and other functional accessories.



ORV™ Suspension
ruggedridge.com

ORV™ offers a full line of heavy duty suspension options to upgrade your vehicles off road capabilities.



Precision Gear®
precisiongear.com

Featuring a full line of heavy duty upgraded ring and pinion sets to make your vehicle run as efficiently as possible.

WARRANTIES

We offer a minimum 3 Year Limited Warranty on all of our products. We've got you covered!



find us on facebook
facebook.com/ruggedridge



**INTERIOR**

FLOOR LINERS	J24
GRAB HANDLES	J35
HARD TOP INSULATION	J23
HEAVY-DUTY OFF ROAD ACCESSORIES	J43-J44
INTERIOR STORAGE	J26
INTERIOR TRIM	J29-J31
OFF ROAD ACCESSORIES	J53
ORGANIZERS	J25-J26
OVERHEAD CONSOLES	J25
INTERIOR ACCESSORIES	J33-J35
SEATING	J27-J28

PERFORMANCE

AIR INTAKES	J45
DUAL BATTERY TRAY	J47
HEADERS/EXHAUST	J44

EXTERIOR

BLACK EXTERIOR ACCESSORIES	J36-J38
BODY ARMOR	J39
BUMPER SYSTEMS	J8-J12
COVERS	J23
DOORS	J32
DOOR ACCESSORIES	J32-J33
EXTERIOR ENHANCEMENTS	J36-J42
FENDER FLARES	J15
OFF ROAD LIGHTING	J49-J52
REPLACEMENT MIRRORS	J33
SKID PLATES	J43
STAINLESS/CHROME EXTERIOR ACCESSORIES	J40-J42
STORAGE BOOT/TIRE COVERS	J22
TOPS/SUMMER BRIEFS/ ISLAND TOPPERS	J18-J21
TUBE STEPS, SIDE PROTECTION	J13-J14
WHEELS & ACCESSORIES	J16-J17
WINCHES & RECOVERY GEAR	J46-48

SUSPENSION

SUSPENSION KITS	J55
SHOCKS & STABILIZERS	J56

AXLE

AXLE KITS	J59
RING & PINIONS	J60
WHEEL SPACERS	J60
AXLE & DIFFERENTIAL COVERS	J60



COASTAL CRUISER

The Coastal Cruiser package by Rugged Ridge® is ideal for the beach and water lover. The package will fit your lifestyle to make everyday an adventure. The items selected that complete the Coastal Cruiser package are not just stylish but also functional. So when the weekend comes take the top down and turn the tunes up, load the cooler and take in that warm summer breeze and smell the fresh coastal air. You now can make every ride feel like you're on vacation if you're at the creek or on the beach.

ROCK RUGGED

Rugged Ridge® knows rugged and we know how to rock your Jeep®. The Rock Rugged package by Rugged Ridge® has all the tools that can take your rig where no one else can. The stylish look and the functionality from the interior to the winch will allow you to make your Jeep® look good and dominate the trails. So if you want a ride that will take you off-road beyond the muddy trails. Make sure your rig is equipped with the Rock Rugged package by Rugged Ridge®, for the serious off-road enthusiast.



TRAIL DUSTER

Now a complete package that can make your everyday driver look good and have the attitude to take you where you want to go. The Trail Duster package by Rugged Ridge® allows you to have the best of both worlds. Now you have the flexibility and the look to do what you want when you want. The Trail Duster will get you to work or through the toughest trails. Don't be left behind, take pride in your ride with the Trail Duster package by Rugged Ridge®.



LOW LANDER

When the urban dweller needs to put a little bling on their ride. The Low Lander package by Rugged Ridge® gives you the look from the exterior chrome to the interior trim. The low Lander package will give you the style and individuality you're looking for. The Low Lander package will make your rig look like it belongs in a show but has the functionality to fit your personal lifestyle.



WEEKEND WILD

Pack the cooler and the tent, throw the bike on the back because the weekend is here. The Weekend Wild package by Rugged Ridge® is built for the weekends. Now when Friday comes your rig can take you places that your boss can't go. From the highway to the byways from 65mph to 10mph your rig will take you where you want to go so you can kick back and enjoy some well deserved R&R with your friends when you put your Jeep® in low gear with the Weekend Wild package by Rugged Ridge®.



COASTAL CRUISER

The Coastal Cruiser package by Rugged Ridge® is ideal for the beach and water lover. The package will fit your lifestyle to make everyday an adventure. The items selected that complete the Coastal Cruiser package are not just stylish but also functional.



2-Door Kit: 12498.01
4-Door Kit: 12498.02

Coastal Cruiser - 07-10 Wrangler (JK) 4-Door	Part #	QTY
Stubby Tube Bumper, With Winch Cutout, Text Black	11561.12	1
8,500lb Winch with Synthetic Rope	15100.02	1
Rear Tube Bumper, Textured Black	11571.10	1
4" Oval Side Tube Steps, Textured Black	11591.08	1
Satin Black Wheels for JK	15301.01	5
Cowl Body Armor	11651.18	1
Windshield Light Brackets, Black	11027.03	1
Slim Light Kit, Black, Pair	15207.58	1
Mirror Relocation Brackets, Black	11025.04	1
Black Grille Inserts	11306.30	1
Headlight Bezels, Black	12419.25	1
Black Door Recess Guards, 4 Dr Kit	11651.26	1
Padded Arm Rest, Gray *	13107.09	1
Ultimate Grab Handles	13505.04	1
Rear Side Grab Handles	13305.14	1
Front Neo Seat Covers, Gray 4 Dr *	13214.09	1
Rear Neo Seat covers, Gray 4 Dr *	13264.09	1
Sunglass Holder/Organizer	12101.52	1
Windshield Header	13308.05	1
Island Topper, 4 Door Diamond Black *	13589.35	1
Front All Terrain Floor Liners	12920.01	1
Rear All Terrain Floor Liners, 4 Door	12950.01	1
All Terrain Cargo Liner	12975.01	1

Coastal Cruiser - 07-10 Wrangler (JK) 2-Door	Part #	QTY
Stubby Tube Bumper, With Winch Cutout, Text Black	11561.12	1
8,500lb Winch with Synthetic Rope	15100.02	1
Rear Tube Bumper, Textured Black	11571.10	1
4" Oval Side Tube Steps, Textured Black	11591.08	1
Satin Black Wheels for JK	15301.01	5
Cowl Body Armor	11651.18	1
Windshield Light Brackets, Black	11027.03	1
Slim Light Kit, Black, Pair	15207.58	1
Mirror Relocation Brackets, Black	11025.04	1
Black Grille Inserts	11306.30	1
Headlight Bezels, Black	12419.25	1
Black Door Recess Guards, 2 Dr Kit	11651.25	1
Padded Arm Rest, Gray *	13107.09	1
Ultimate Grab Handles	13505.04	1
Front Neo Seat Covers, Gray 2 Dr *	13214.09	1
Rear Neo Seat covers, Gray 2 Dr *	13265.09	1
Sunglass Holder/Organizer	12101.52	1
Windshield Header	13308.05	1
Island Topper, 2 Door Diamond Black *	13588.35	1
Front All Terrain Floor Liners	12920.01	1
Rear All Terrain Floor Liners, 2 Door	12950.02	1
All Terrain Cargo Liner	12975.01	1

*Fits 2007-2010 Wranglers only. Separate applications available for 2011-2012 vehicles.

ROCK RUGGED

Rugged Ridge® knows rugged and we know how to rock your Jeep®. The Rock Rugged package by Rugged Ridge® has all the tools to take your rig where no one else can. The stylish look and the functionality from the interior to the winch will allow you to make your Jeep® look good and dominate the trails.



2-Door Kit: 12498.11
4-Door Kit: 12498.12

Rock Rugged - 07-10 Wrangler (JK) 4-Door

Part #	QTY
XHD Center Base With Winch Cutout	11540.10 1
XHD Stinger	11540.13 1
D-Rings	11235.01 1
XHD Rear Bumper	11546.20 1
XHD Rear Bumper Tire Carrier	11546.22 1
Off Road Jack Mount	11586.01 1
Tire Carrier Linkage	11503.91 1
RRC Rock Sliders, 4 Door	11504.22 1
Front Skid Plate for JK	18003.30 1
Evap Skid Plate for JK**	18003.40 1
Muffler Skid for JK	18003.31 1
Front/Rear Control Arm Skids for JK	18003.37 1
4" ORV™ Lift Kit With Shocks	18415.60 1
Drop Pitman Arm, JK	18006.55 1
10,500lb Winch with Synthetic Rope	15100.11 1
Flat Fender Flares for JK	11620.10 1
Satin Wheels for JK	15301.01 5
Black Rim Protectors	15250.02 5
Cowl Body Armor	11651.18 1
Dual Battery Tray, JK**	11214.53 1
Windshield Mount Light Bar	11232.21 1
7" HID Lighting Kit, 2pc	15205.53 1
7" HID Lighting Kit, 3pc	15205.63 1
Mirror Relocation Brackets, Black	11025.04 1
Front Headlight Euro Guards	11230.03 1
Turn Signal Euro Guards	11231.11 1
Rear Euro Guards, Black	11226.02 1
Locking Black SS Fuel Cover	11229.03 1
Padded Arm Rest, Gray *	13107.01 1
Ultimate Grab Handles	13505.04 1
Rear Side Grab Handles	13305.14 1
Fire Extinguisher Holder, Roll Bar Mount	13305.21 1
Roll Bar Flashlight Holder	11205.20 1
Front Seat Protectors, Black	13235.30 1
Dash Organizer/CB Mount*	13551.10 1
Front All Terrain Floor Liners	12920.01 1
Rear All Terrain Floor Liners, 4 Door	12950.01 1
All Terrain Cargo Liner	12975.01 1

Rock Rugged - 07-10 Wrangler (JK) 2-Door

Part #	QTY
XHD Center Base With Winch Cutout	11540.10 1
XHD Stinger	11540.13 1
D-Rings	11235.01 1
XHD Rear Bumper	11546.20 1
XHD Rear Bumper Tire Carrier	11546.22 1
Off Road Jack Mount	11586.01 1
Tire Carrier Linkage	11503.91 1
RRC Rock Sliders, 4 Door	11504.23 1
Front Skid Plate for JK	18003.30 1
Evap Skid Plate for JK**	18003.40 1
Muffler Skid for JK	18003.31 1
Front/Rear Control Arm Skids for JK	18003.37 1
5" ORV™ Lift Kit With Shocks	18415.60 1
Drop Pitman Arm, JK	18006.55 1
8,500lb Winch with Synthetic Rope	15100.02 1
Flat Fender Flares for JK	11620.10 1
Satin Wheels for JK	15301.01 5
Black Rim Protectors	15250.02 5
Cowl Body Armor	11651.18 1
Dual Battery Tray, JK**	11214.53 1
Windshield Mount Light Bar	11232.21 1
7" HID Lighting Kit, 2pc	15205.53 1
7" HID Lighting Kit, 3pc	15205.63 1
Mirror Relocation Brackets, Black	11025.04 1
Front Headlight Euro Guards	11230.03 1
Turn Signal Euro Guards	11231.11 1
Rear Euro Guards, Black	11226.02 1
Locking Black SS Fuel Cover	11229.03 1
Padded Arm Rest, Gray *	13107.01 1
Ultimate Grab Handles	13505.04 1
Fire Extinguisher Holder, Roll Bar Mount	13305.21 1
Roll Bar Flashlight Holder	11205.20 1
Front Seat Protectors, Black	13235.30 1
Dash Organizer/CB Mount*	13551.10 1
Front All Terrain Floor Liners	12920.01 1
Rear All Terrain Floor Liners, 4 Door	12950.02 1
All Terrain Cargo Liner	12975.01 1

*Fits 2007-2010 Wranglers only. Separate applications available for 2011-2012 vehicles.
**Fits 2007-2011 Wranglers only.



Now a complete package that can make your everyday driver look good and have the attitude to take you where you want to go. The Trail Duster package by Rugged Ridge® allows you to have the best of both worlds. Now you have the flexibility and the look to do what you want when you want.

2-Door Kit: 12498.21
4-Door Kit: 12498.22

Wrangler 07-12

Trail Duster - 07-10 Wrangler (JK) 4-Door	Part #	QTY
XHD Center Base With Winch Cutout	11540.10	1
Standard Ends for XHD	11540.12	1
Hoop Overrider	11540.14	1
XHD Rear Bumper	11546.20	1
XHD Rear Bumper Tire Carrier	11546.22	1
Off Road Jack Mount	11586.01	1
Tire Carrier Linkage	11503.91	1
RRC Side Armor 4 Door	11504.20	1
Front Skid Plate for JK	18003.30	1
2.5" ORV™ Lift Kit With Shocks	18415.50	1
10,500lb Winch With Steel Cable	15100.10	1
Roller Fairlead License Plate Holder	11238.05	1
Satin Black Wheels for JK	15301.01	5
Black Rim Protectors	15250.02	5
Cowl Body Armor	11651.18	1
5" HID Lighting Kit, Pair	15205.54	1
Light Mount Clamp	11503.82	2
Mirror Relocation Brackets, Black	11025.04	1
Front Headlight Euro Guards	11230.03	1
Parking Light Euro Guards	11231.11	1
Rear Euro Guards, Black	11226.02	1
Locking Black Fuel Cover	11229.03	1
Padded Arm Rest, Black *	13107.01	1
Ultimate Grab Handles	13505.04	1
Rear Side Grab Handles	13305.14	1
Fire Extinguisher Holder, Roll Bar Mount	13305.21	1
Roll Bar Flashlight Holder	11205.20	1
Front Seat Protectors, Black	13235.30	1
Dash Organizer/CB Mount*	13551.10	1
Front All Terrain Floor Liners	12920.01	1
Rear All Terrain Floor Liners, 4 Door	12950.01	1
All Terrain Cargo Liner	12975.01	1

Trail Duster - 07-10 Wrangler (JK) 2-Door	Part #	QTY
XHD Center Base With Winch Cutout	11540.10	1
Standard Ends for XHD	11540.12	1
Hoop Overrider	11540.14	1
XHD Rear Bumper	11546.20	1
XHD Rear Bumper Tire Carrier	11546.22	1
Off Road Jack Mount	11586.01	1
Tire Carrier Linkage	11503.91	1
RRC Side Armor 2 Door	11504.21	1
Front Skid Plate for JK	18003.30	1
3.5" ORV™ Lift Kit With Shocks	18415.50	1
8,500lb Winch With Steel Cable	15100.01	1
Roller Fairlead License Plate Holder	11238.05	1
Satin Black Wheels for JK	15301.01	5
Black Rim Protectors	15250.02	5
Cowl Body Armor	11651.18	1
5" HID Lighting Kit, Pair	15205.54	1
Light Mount Clamp	11503.82	2
Mirror Relocation Brackets, Black	11025.04	1
Front Headlight Euro Guards	11230.03	1
Parking Light Euro Guards	11231.11	1
Rear Euro Guards, Black	11226.02	1
Locking Black Fuel Cover	11229.03	1
Padded Arm Rest, Black *	13107.01	1
Ultimate Grab Handles	13505.04	1
Fire Extinguisher Holder, Roll Bar Mount	13305.21	1
Roll Bar Flashlight Holder	11205.20	1
Front Seat Protectors, Black	13235.30	1
Dash Organizer/CB Mount*	13551.10	1
Front All Terrain Floor Liners	12920.01	1
Rear All Terrain Floor Liners, 2 Door	12950.02	1
All Terrain Cargo Liner	12975.01	1

*Fits 2007-2010 Wranglers only. Separate applications available for 2011-2012 vehicles.

**Fits 2007-2011 Wranglers only.

LOW LANDER

When the urban dweller needs to put a little bling on their ride. The Low Lander package by Rugged Ridge® gives you the look from the exterior chrome to the interior trim. The low Lander package will give you the style and individuality you're looking for.



2-Door Kit: 12498.31
4-Door Kit: 12498.32

Low Lander - 07-10 Wrangler (JK) 4-Door

Part #	QTY
11563.10	1
11573.10	1
11593.08	1
15301.20	5
11116.06	1
11101.04	1
11112.03	1
13311.18	1
11113.06	1
13311.03	1
13311.21	1
13311.26	1
11306.20	1
13311.20	1
11142.04	1
11142.11	1
11142.12	1
11103.03	1
11134.02	1
13107.09	1
13505.04	1
13305.14	1
13214.09	1
13264.09	1
12101.52	1
11420.06	1
11156.96	1
13551.15	1
12920.01	1
12950.01	1
12975.01	1

Low Lander - 07-10 Wrangler (JK) 2-Door

Part #	QTY
11563.10	1
11573.10	1
11593.08	1
15301.20	5
11116.06	1
11101.04	1
11112.03	1
13311.17	1
11113.05	1
13311.03	1
13311.21	1
13311.26	1
11306.20	1
13311.20	1
11142.04	1
11142.11	1
11142.12	1
11103.03	1
11134.02	1
13107.09	1
13505.04	1
13214.09	1
13264.09	1
12101.52	1
11420.06	1
11156.96	1
13551.15	1
12920.01	1
12950.01	1
12975.01	1

*Fits 2007-2010 Wranglers only. Separate applications available for 2011-2012 vehicles.



Wrangler 07-12

Weekend Wild - 07-10 Wrangler (JK) 4-Door

Part #	QTY
XHD Center Base With Winch Cutout	11540.10 1
Standard Ends for XHD	11540.12 1
XHD Rear Bumper	11546.20 1
Rear 2" Receiver Hitch, JK	11580.10 1
Receiver Hitch Shackle Bracket	11234.01 1
Lockable Spare Tire Mount Bike Rack	11237.10 1
Spare Tire Spacer	11585.02 1
RRC Side Armor, 4-Door	11504.20 1
2.5" ORV™ Lift Kit with Shocks	18415.50 1
10,500lb Winch with Steel Cable	15100.10 1
Roller Fairlead License Plate Holder	11238.05 1
Satin Black with Machined Lip Wheels for JK	15301.10 5
Cowl Body Armor	11651.18 1
Body Armor Corner Guards, 4-Door JK	11651.01 1
Windshield Light Brackets, Black	11027.03 1
Slim Light Kit, Black, Pair	15207.58 1
Front Headlight Euroguards	11230.03 1
Parking Light Euroguards	11231.11 1
Side Marker Light Euroguards	11231.12 1
Grille Inserts, Black	11306.30 1
Headlight Bezels, Black	12419.25 1
Rear Euroguards, Black	11226.02 1
Locking Black Fuel Cover	11229.03 1
Black Door Recess Guards	11651.26 1
Padded Arm Rest, Black *	13107.01 1
Ultimate Grab Handles	13505.04 1
Rear Side Grab Handles	13305.14 1
Fire Extinguisher Holder, Roll Bar Mount	13305.21 1
Interior Trim, Silver *	11151.96 1
Roll Bar Flashlight Holder	11205.20 1
Front Seat Protectors, Black	13235.30 1
Rear Seat Organizer, JK *	13551.15 1
Dash Organizer/CB Mount *	13551.10 1
Front All Terrain Floor Liners	12920.01 1
Rear All Terrain Floor Liners, 4-Door	12950.01 1
All Terrain Cargo Liner	12975.01 1

Weekend Wild - 07-10 Wrangler (JK) 2-Door

Part #	QTY
XHD Center Base With Winch Cutout	11540.10 1
Standard Ends for XHD	11540.12 1
XHD Rear Bumper	11546.20 1
Rear 2" Receiver Hitch, JK	11580.10 1
Receiver Hitch Shackle Bracket	11234.01 1
Lockable Spare Tire Mount Bike Rack	11237.10 1
Spare Tire Spacer	11585.02 1
RRC Side Armor, 4-Door	11504.20 1
3.5" ORV™ Lift Kit with Shocks	18415.50 1
10,500lb Winch with Steel Cable	15100.10 1
Roller Fairlead License Plate Holder	11238.05 1
Satin Black with Machined Lip Wheels for JK	15301.10 5
Cowl Body Armor	11651.18 1
Body Armor Corner Guards, 2-Door JK	11651.01 1
Windshield Light Brackets, Black	11027.03 1
Slim Light Kit, Black, Pair	15207.58 1
Front Headlight Euroguards	11230.03 1
Parking Light Euroguards	11231.11 1
Side Marker Light Euroguards	11231.12 1
Grille Inserts, Black	11306.30 1
Headlight Bezels, Black	12419.25 1
Rear Euroguards, Black	11226.02 1
Locking Black Fuel Cover	11229.03 1
Black Door Recess Guards	11651.25 1
Padded Arm Rest, Black *	13107.01 1
Ultimate Grab Handles	13505.04 1
Fire Extinguisher Holder, Roll Bar Mount	13305.21 1
Interior Trim, Silver *	11151.96 1
Roll Bar Flashlight Holder	11205.20 1
Front Seat Protectors, Black	13235.30 1
Rear Seat Organizer, JK *	13551.15 1
Dash Organizer/CB Mount *	13551.10 1
Front All Terrain Floor Liners	12920.01 1
Rear All Terrain Floor Liners, 2-Door	12950.01 1
All Terrain Cargo Liner	12975.01 1

*Fits 2007-2010 Wranglers only. Separate applications available for 2011-2012 vehicles.

XHD MODULAR BUMPER SYSTEM

THE MOST ADVANCED, TOUGHEST, MOST FLEXIBLE BUMPER SYSTEM EVER CREATED!

It's over 100 bumpers in one! You won't find a more versatile bumper system. Go from hardcore to street savvy with just a few hand tools.

Wrangler 07-12

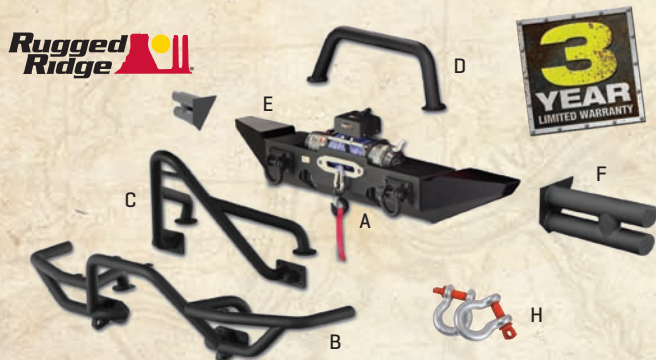

Winch Mount Base - 11540.10
Hoop Over-Rider - 11540.14
Stubby Ends - 11540.23

No other bumper can give your Jeep® this many looks. Modular design provides dozens of different looks and styles. You can build the exact bumper of your choice! Custom designed for the 2007-2012 Jeep® Wranglers, each component maximizes the oversized look of the vehicle. All components are constructed of heavy-duty textured black powder coated steel with a tough E-Coat under-coating or polished, no rust, prime 304 stainless steel for the ultimate look! These tough finishes will provide years of heavy-duty use. Matching rear bumpers are available for a complete look.

Application

Application	Part #
Short Base, Winch Mount, Textured Black D-Rings, 07-12 Wrangler [A]	11540.10
Short Base, Light Mount, Textured Black D-Rings, 07-12 Wrangler	11540.11
RRC Mount, 2.5" Tube, Textured Black for XHD Bumper, 07-12 Wrangler [B]	11540.18
Stinger, 2" Textured Black for XHD Bumper, 07-12 Wrangler [C]	11540.13
Hoop Over-Rider, 60mm Textured Black for XHD Bumper, 07-12 Wrangler [D]	11540.14
Standard Ends, Textured Black for XHD Bumper, 07-12 Wrangler [E]	11540.12
Storage Ends, Textured Black for XHD Bumper, 07-12 Wrangler* NEW [F]	11540.22
Tube Ends, Textured Black for XHD Bumper, 07-12 Wrangler NEW [F]	11540.21
Stubby Ends, Textured Black for XHD Bumper, 07-12 Wrangler NEW [F]	11540.23
D-Rings, Pair For Use With Stinger & RRC D-Ring Mounts, 07-12 Wrangler [G]	11235.01
Mounting Plates For Warn Power Plant Winch (for use on 11540.10 XHD Bumper only)	11540.15
D-Rings, Pair For Use With Bumper Base, 07-12 Wrangler (Included with XHD Bumper base) NEW [H]	11235.01

Storage ends will not work with the [B] RRC front bumper

XHD TUBE ENDS

Add tube ends to your XHD bumper for added protection and a classic OE look! XHD Tube Ends offer wraparound protection and added clearance for oversized tires. Available in either textured black powder coat or polished 304 stainless steel for a long lasting durable finish.



XHD STORAGE ENDS



11540.22
Storage Ends,
Black

Looking for an easily accessible yet secure storage solution for your Wrangler? XHD Storage Ends from Rugged Ridge® turn your bumper into a stylish watertight storage vault. The XHD Storage ends are a great place to stow recovery gear and other valuables. Beefy steel construction, a watertight seal, and lockable lid helps keep mud and water out and your gear in.

XHD Tube Ends

XHD Tube Ends	Part #
Tube Ends, Textured Black for XHD Bumper, 07-12 Wrangler NEW	11540.21
Tube Ends, Stainless Steel for XHD Bumper, 07-12 Wrangler NEW	11540.73

XHD Storage Ends

XHD Storage Ends	Part #
Storage Ends, Textured Black, 07-12 Wrangler NEW	11540.22

ALSO AVAILABLE IN STAINLESS FOR A WHOLE NEW LOOK!

Nothing lasts as long or stands up to the elements like stainless steel. Not only do you get a bright shiny finish, but the long lasting durability of prime 304 stainless!

XHD Bumper System (Stainless Steel)

XHD Bumper System (Stainless Steel)	Part #
Short Base, Light Mount, Stainless Steel, Stainless D-Rings, 07-12 Wrangler*	11540.71
Hoop Over-Rider, 60mm Stainless for XHD Bumper, 07-12 Wrangler**	11540.16
Standard Ends, Stainless for XHD Bumper, 07-12 Wrangler Pair	11540.19
Tube Ends, Stainless for XHD Bumper, 07-12 Wrangler Pair NEW	11540.73
Polished Stainless D-Rings, Replaces Standard XHD D-Rings, 07-12 Wrangler Pair	11540.17

* Includes Stainless D-Rings ** Will not work with Warn Power Plant Winch.



Note: XHD Modular Bumper Components Do Not Interchange With XHD Aluminum Bumper Components

NEW!

XHD ALUMINUM BUMPER SYSTEM



Designed to be a whole new look while being extremely light weight. Save on fuel and the need for front suspension spacers. The Bumper is all Aluminum but uses the current steel XHD D-rings. Each bumper comes with a built in top filler plate. Each new XHD has cutouts and mounting points for the factory fog lights and a great looking "Jeep® Style" front slat look that will make this bumper stand out. If you want to run a winch, simply remove the filler plate and attach the optional JK Winch mounting plate [Steel Plate]. The XHD Aluminum bumper is approximately 80lbs+ lighter than the average steel off road bumper. Government studies show a fuel economy benefit of 2% for every 100lbs of weight savings.**

Available Components:

- Aluminum Center Section with Steel D-Rings
- Stubby Bumper Ends - Aluminum
- JK Winch Plate - Special design for this bumper
- Special Aluminum Over-rider with front slope

** Aluminum XHD Bumper Components do not interchange with Steel XHD Bumper Components

**<http://www.fueleconomy.gov/feg/driveHabits.shtml>

Just How Light is the Aluminum XHD Bumper?

Front Bumper	Weight
Aluminum XHD - Standard Configuration*	26.9lbs
OE Bumper	35.7lbs
Brand X Off Road Bumper	110lbs & Up

*Standard Configuration: Bumper Base, Filler Plate & D-Rings. The optional Hoop Over-rider, Stubby Ends & Winch Plate make the maximum overall weight of the bumper 62.6lbs.



JK Aluminum Front Bumper,

	Part #
07-12 Wrangler Non-Winch, Textured Blk, NEW	11541.02
07-12 Wrangler With Winch, Textured Blk, NEW	11541.01
07-12 Wrangler Winch Plate, NEW	11541.13
07-12 Wrangler Front Bumper Ends, ¹ NEW	11541.10
07-12 Wrangler Over Rider, ¹ NEW	11541.14

¹ Not compatible w/ 11540.10 or 11540.11

XHD ALUMINUM REAR BUMPER PODS



Taking the light weight theme further, we have developed steel inner framed Aluminum Rear Bumper Pods. These new lightweight Pods still allow for over sized tires but take a huge chunk of weight out of the bumper. [The picture shows the rear pods installed with the enclosed steel D rings for the XHD Rear Tire Carrier]. Each Pod can be used with tire carrier part #11546.20 to hang those 35"+ tires shown in picture with the optional center step. The XHD Aluminum bumper pods are approximately 40lbs+ lighter than the average steel off road bumper. Government studies show a fuel economy benefit of 2% for every 100lbs of weight savings.**

**<http://www.fueleconomy.gov/feg/driveHabits.shtml>

Just How Light is the Aluminum XHD Rear Bumper?

Rear Bumper	Weight
Aluminum XHD - Standard Configuration*	43.45lbs
OE Plastic Bumper Cover	16.5lbs
Brand X Off Road Bumper	85lbs & Up

*Standard Configuration: Pods, Brackets & D-Rings. The optional Step adds an additional 6lbs.



JK Aluminum Rear Bumper

	Part #
07-12 Wrangler XHD Bumper Pods, Textured Blk, NEW	11547.01
07-12 Wrangler XHD Bumper Pod Center Step, Textured Blk, NEW	11547.10

*See page J10 for tire carrier option. Part# 11546.20

All images are subject to be representative. More detailed information is available online.

XHD REAR BUMPER SYSTEM FOR 2007-12 WRANGLER

Make the most of your rear bumper with our XHD Rear Bumper System. Features easy installation, amazing looks and two reinforced heavy-duty D-Ring attachment points. Special "inner mounting plate" provides an extremely secure mounting point - strong enough for off-road use! The two-piece design allows use with and without tire carrier options. Heavy-duty powder coated steel design looks great but is extremely tough. Mount on the optional Tire Carrier and you can hold up to a 35" tire.



D-rings attach securely to the frame of the vehicle for a rock solid recovery mounting point.



Xtreme Heavy-Duty Rear Bumper

Rear XHD Bumper, Textured Black, 07-12 Wrangler

Rear Receiver Hitch, 07-12 Wrangler

Part

11546.20

11580.10

XHD TIRE CARRIER MOUNT FOR 2007-12 WRANGLER

The perfect addition to the XHD Rear Bumper & XHD Aluminum Rear Bumper is the matching XHD Tire Carrier Mount. The latch uses a sturdy locking mechanism for security and a tough appearance. Our engineers have gone to great lengths to make this the quietest tire carrier on the market, no more rattling! The massive hinge pivots on a heavy-duty roller bearing and supports up to a 35" tire. A multi-position locking pin mechanism keeps the arm in the open position when you need to open the tailgate, even on the steepest grade. The XHD Tire Carrier Mount attaches to the XHD Rear Bumpers using the D-ring mounts for a solid foundation.

Latching Mechanism With Attached Security Pin Keeps Your Carrier Secure

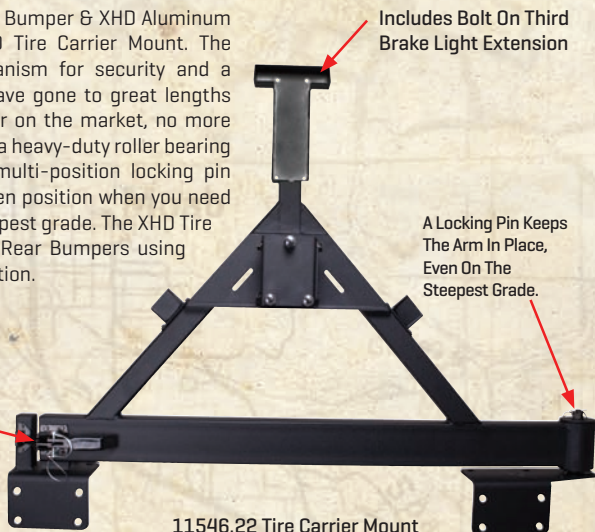

Includes Bolt On Third Brake Light Extension

A Locking Pin Keeps The Arm In Place, Even On The Steepest Grade.

11546.22 Tire Carrier Mount



The Massive Tapered Greasable Dual Roller Bearing Hinge Supports Up To a 35" Tire.

XHD Tire Carrier Mount

Tire Carrier Mount Add-on for 11546.20 & 11547.01, Textured Black 07-12 Wrangler

Part

11546.22

TIRE CARRIER LINKAGE

Has opening your rear tailgate become a burden since you added a swing out tire carrier? Has it become easier to crawl over the rear seat to grab your gear, than hassling with the tire carrier? The Rugged Ridge® Tire Carrier Linkage Kit eliminates the issue and makes accessing the cargo area quick and painless. Once installed the linkage mates the tire carrier to the tailgate, so both open in a single fluid movement. The Tire Carrier Linkage is designed to work with Rugged Ridge® XHD, rear bumper and tire carriers, but will also work with most other aftermarket tire carriers. No drilling is required to mount the linkage to the tailgate, but some minor drilling is required to mount the linkage to the tire carrier.

Tire Carrier Linkage

Tire Carrier Linkage, 07-12 Wrangler (JK) **NEW**

Part

11503.91



TIRE CARRIER RECOVERY (TCR) BAG

The TCR bag has been designed to mount to Rugged Ridge® RRC, XHD & Classic rear tire carrier bumpers. This bag allows the storage of all your recovery gear between the A-frame uprights on your rear tire carrier. Constructed of weather resistant material & features a zipper flap to help protect your gear from the environment. Attaches easily with 4 heavy-duty nylon straps that allow for quick removal and transport.

Tire Carrier Recovery Bag (Each)

TCR Bag Fits XHD Rear Bumper with Tire Carrier

Part

12801.50



Carries Recovery Gear (not included)



Removable with Handy Carry Handle

REAR TUBE BUMPER FOR 2007-12 JEEP® WRANGLER

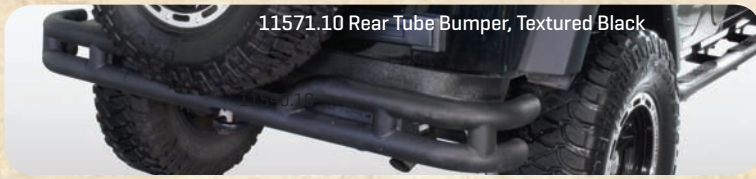

11571.10 Rear Tube Bumper, Textured Black

Get the off-road look with a Rugged Ridge® Tube Bumper! Each bumper has smooth ground welds, welded end caps (not plastic end caps!) and the unique style only available from Rugged Ridge®. Center tire cut-out allows for larger tires while still keeping that off-road look, accommodates tire sizes up to 35". Each rear tube bumper includes a special UV treated textured plastic filler plate to fill in the gap between the body and the bumper, a Rugged Ridge® exclusive.



Welded end caps, not plastic!



Textured plastic filler plate fills in the gap between the body and the bumper, a Rugged Ridge® exclusive.

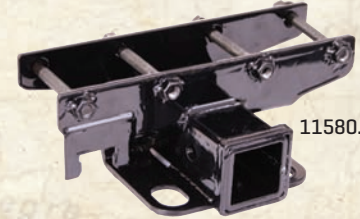

11580.10

Rear Tube Bumper	Textured Black	Stainless
Rear Tube Bumper, 07-12 Wrangler	11571.10	11573.10

Rear Receiver Hitch	Part #
Rear Receiver Hitch, 07-12 Wrangler	11580.10
Rear Receiver Hitch with OE Style Wiring Harness, 07-12 Wrangler NEW	11580.51

The Rugged Ridge® RRC Rear Bumper provides the off road protection you are looking for! The frame mounted platform features a heavy-duty grid like system with raised sides for the ultimate protection and greatest ground clearance. Each RRC bumper is constructed of durable powder coat painted .120 wall welded end cap steel tubing for long life and extreme durability. RRC Rear Bumper also features a reinforced hitch box that is designed for off-road accessories (not designed or rated for towing. Use only for accessories). To make your vehicle look its very best, we have enclosed a rear filler plate that completes the look of your bumper and hides un-sightly under carriage parts.

RRC REAR BUMPERS



11503.15 RRC Bumper with Hitch for 07-12 Wrangler



RRC Rear Bumpers	Textured Black
07-12 Wrangler, RRC Rear Bumper w/Hitch Each	11503.15

CAUTION: Receiver not designed or rated for towing. Use only for accessories (bike rack, etc.)



11586.01

OFF ROAD JACK MOUNT

JK Off-Road Jack Mount allows you to carry your Off-Road jack on the outside of your vehicle saving precious cargo space. Fast and easy bolt on installation. Compatible with stock and most aftermarket rear bumpers (without tire carriers) as well as Rugged Ridge® XHD rear bumper with or without tire carrier. Bracket is sturdy and secures the jack in two locations to eliminate any vibration noise during vehicle operation. Durable textured finish looks great. Fits most off-road style jacks including Hi-Lift™.

Each Jack mount incorporates a special round cutout for padlock use.

Quick Release Knob Allows For Easy Jack Attachment/Removal



NEW!

Fits All Original Equipment And Rugged Ridge® XHD Rear Bumpers

Off Road Jack Mount	Part #
Off Road Jack Mounting Bracket, Hi-Lift Style, Jeep® Wrangler 07-12, Pair NEW	11586.01



11503.89

CB ANTENNA MOUNT

Easily and quickly install your CB antenna to your Jeep® with the new Rugged Ridge® spare tire carrier mount antenna mount. This durable mounting bracket installs directly to factory tire carrier on 2007-current Jeep® Wranglers without drilling. Each powder coat painted textured black steel bracket is extremely durable and provides a hidden mounting point for your CB or off road antenna. Each antenna mount includes mounting hardware and bracket.

Spare Tire Carrier CB Antenna Mount	Part #
Spare Tire Carrier CB Antenna Mount, 07-12 Wrangler, NEW	11503.89

All images are subject to be representative. More detailed information is available online.

FRONT TUBE BUMPERS FOR 2007-12 WRANGLERS
2007-12 WRANGLER DESIGN

Wrangler 07-12

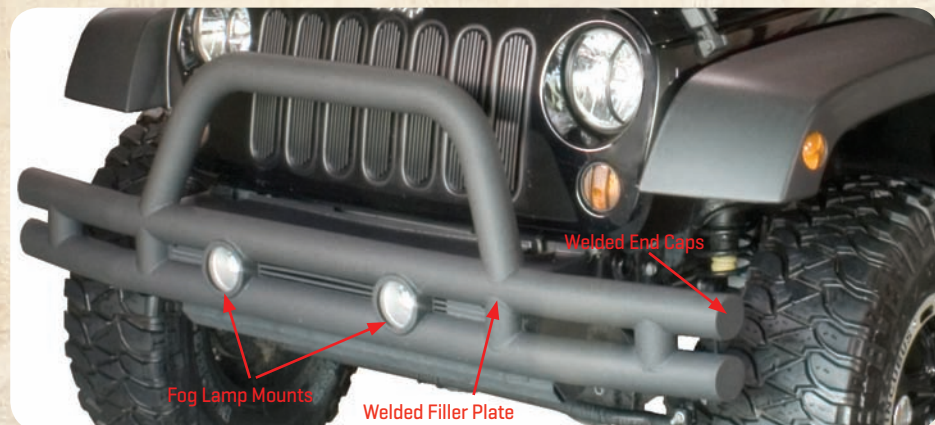

11561.10 Front Bumper, Textured Black w/ Winch Cut-Out, 07-12 Wrangler

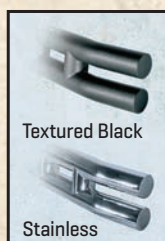

Front Bumpers	Front Bumper with Riser	Black	Textured Black	Stainless
07-12 Wrangler *	Front Tube Bumper w/Riser	-	11561.10	11563.10
07-12 Wrangler * [1]	Front Bumper w/ Built-in Winch Plate	-	11561.11	-
For All Tube Bumpers	License Plate Mounting Bracket	11503.80	-	-
For All Tube Bumpers	Light Mounting Bracket Each	11503.81	-	-
For All Tube Bumpers	CB Antenna Mounting Bracket Each	11503.88	-	-

* Fits 2 & 4-Door. 2007-12 Wrangler, has cut-outs for OE foglamps. [1] Winch mount plate included.

JK STUBBY TUBE BUMPER

Rugged Ridge® has taken their industry leading Front Tube Bumper and re-designed the ends to make the ultimate high clearance off-road winch bumper. This unique design has a built-in winch mount and special cut-outs for the JK Wrangler factory fog lamps. Like our regular tube bumper, we have cut into the front tubing allowing the bumper to "hug" the front end of the Jeep®. Each bumper includes durable welded end caps and polished smooth welds for the ultimate in durability. NEW: Special inside pre-coat eliminates any chance of interior rusting. A Rugged Ridge® Exclusive!



NEW!

Stubby Tube Bumper	Part #
Stubby Tube Bumper, 07-12 Wrangler [JK] Each NEW	11561.12

BULL BARS FOR 07-12 WRANGLER

Get that heavy-duty look with a Bull Bar from Rugged Ridge®! Each design has been custom designed for your JK Wrangler utilizing tough 3/8"-1/4" thick heavy-duty mounting brackets. Each Bull Bar offers smooth ground welds and laser cut skid plates. The black model has a dual stage powder coat finish with a tough E-coat under coating. The polished stainless version has been polished to a mirror finish providing a beautiful look on your Jeep®.

Pre-drilled light tabs for off-road light mounting.

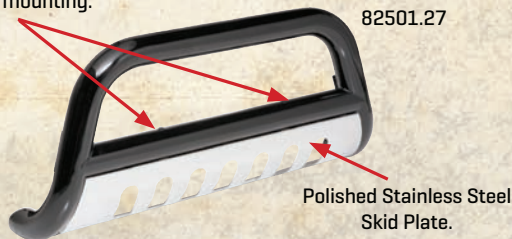

Bull Bars For 07-12 Wrangler	Part #
3 Inch Black Powder Coated Each	82001.27
3 Inch Stainless Steel Each	82501.27

BUMPER APPLIQUÉS

Make your NEW Wrangler look like a Sahara model with this beautiful new Rear Bumper Appliqué from Rugged Ridge®. Constructed of impact resistant polymers, this custom fit appliqué will dress up the front of your original equipment bumper easily and quickly. Installing with screws to the back of your bumper (just like original equipment!), this appliqué is a quick up-grade or an inexpensive replacement.



NEW!

Matches OE Sahara Finish!



Bumper Appliqués	Part #
Bumper Applique, Front, Silver, Jeep® Wrangler [JK] 07-10	12040.08
Bumper Applique, Rear, Silver, Jeep® Wrangler [JK] 07-10	12040.09

RRC SIDE ARMOR



2" x 12" Wall Construction, Black Texture Powder Coat Finish

Resists Scratches & Is Slip Resistant

11054.20 RRC Side Armor, Textured Black, 07-12 4-Door Wrangler

Keep your rocker panels from being beaten to a pulp on the trail with Rugged Ridge® Side Armor. Built from heavy-duty 2" x 0.120" black texture powder coated steel tubing, these guards will take the beating that was meant for your sheet metal. JK models feature a simple bolt-on design that utilizes existing body mount locations for a secure, rattle free installation. The black texture finish resists scratches and gives a slip-resistant surface for door entry. Sold as a pair and includes all necessary installation hardware.



07-12 Wrangler models have simple bolt on design. Utilizes existing body mount locations on frame.

RRC Side Armor	Textured Black
07-12 Wrangler, 4-Door Pair	11504.20
07-12 Wrangler, 2-Door Pair	11504.21

RRC ROCK SLIDERS



11504.23 RRC Rock Slider, Textured Black, 07-12 2-Door Wrangler

This true Rock Crawling design puts protection tight up under the side of your Jeep® while adding a special side "hoop" to block those large outcroppings. Special no drill frame mounted design provides secure, bounce-free installation while keeping the mounting points above the bottom of the frame for greater ground clearance. Each RRC Rock slider mounts to your Wrangler using a simple bolt on frame mount design for ease of installation and extra durability.



11504.22 RRC Rock Slider, Textured Black, 07-12 4-Door Wrangler

RRC Rocker Guards	Textured Black
07-12 Wrangler 4-Door Pair	11504.22
07-12 Wrangler 2-Door Pair	11504.23

SIDE TUBE STEPS

Complete the look with a set of Rugged Ridge® tubular tough duty side steps. Available in 3" round, 4" round, and 4.25" oval diameter sizes. The large 4.25" oval and 4" round tubes provide a much cleaner look and are not "dwarfed" by oversized tires and oversized body style features of the 2007-12 Wrangler. Rugged Ridge® Stainless Steel Tube Steps feature prime 304L, .05" wall stainless tubing polished to a mirror finish. The polishing process for a Rugged Ridge® step is longer and deeper pulling out the deepest shine from the steel. A true "deep polish"! Rugged Ridge® painted steel Tube Steps feature special E-coated, .07" wall steel that is "thick source" powder coated for a tough chip resistant finish. The special E-coat undercoating provides double rust protection as it bonds to the metal creating a protective layer found nowhere else. All Rugged Ridge® Tube steps feature a truly custom fit with installation brackets constructed of durable 3/16" powder coated steel for long life and years of flex-free use. Each Tube Step features special UV treated no-slip step pads with 5 mounting pins. These step pads are preinstalled on top of the tube - no exposed metal to rust. All 2007-12 Wrangler models are no drill designs.



3" Round Tube Step, Black



3" Round Tube Step, Textured Black



3" Round Tube Step, Stainless Steel

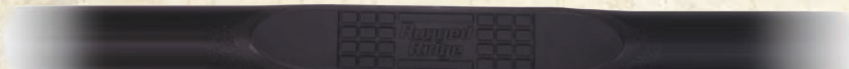

4 1/4" Oval Tube Step, Textured Black

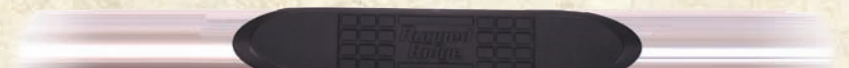

4 1/4" Oval Tube Step, Stainless Steel



4" Round Tube Step, Stainless Steel

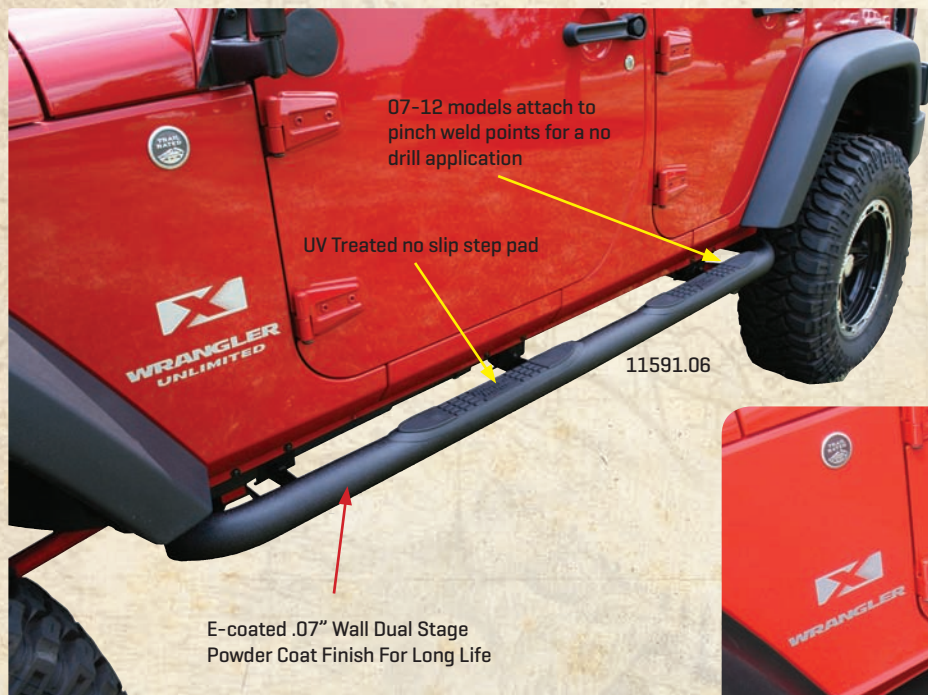

Side Tube Steps

	Black	Textured Black	Stainless
07-12 Wrangler 3" Round, 2-Door Pair	11590.05	11591.05	11593.05
07-12 Wrangler 3" Round, 4-Door Pair	11590.06	11591.06	11593.06
07-12 Wrangler 4" Round, 2-Door Pair	-	-	11593.09
07-12 Wrangler 4" Round, 4-Door Pair	-	-	11593.10
07-12 Wrangler 4 1/4" Oval, 2-Door Pair	-	11591.07	11593.07
07-12 Wrangler 4 1/4" Oval, 4-Door Pair	-	11591.08	11593.08

ALL-TERRAIN FLAT FENDER FLARES

Now, with the NEW All-Terrain Flat Fender Flares from Rugged Ridge® you can add a bigger tire option for a true off road look. You can also use in combination with a suspension lift for maximum off road performance. These exciting new flares are out-of-the-box ready to turn your street Jeep® into an off road machine. By removing your original flares and replacing them with these high clearance designs, you can run larger tires without interference from the flare. The ability to run a larger tire with little or no suspension lift means a "lower center of gravity" making your JK more stable, yet you still get greater ground clearance necessary for off road. With 1.5 inches less coverage in the front and 1 inch less in the rear these flares are slightly narrower than factory, yet still maintain proper tire coverage and aggressive looks. Constructed of a flexible UV treated high impact thermoplastic, these flares are designed for the trail and create a whole new look for your JK. Easy to install, these flares replace your factory flares, attaching to the factory mounting points with no drilling. Simply remove your original flares and add on the All Terrain flares. The kit also includes easy to install mounting brackets that allow you to relocate and use the existing factory side marker lights. The All Terrain Flat Fender Flare is the hottest looking, most functional Off Road Flare available for your JK! Finally, because no cutting or drilling is required, if you ever want to switch back to your original factory flares, there's no problem!



Special side marker light brackets included for use with your factory side marker light



All Terrain Flat Fender Flare Kit

	Part #
Flat Fender Flare Kit, 07-12 Wrangler 2 and 4-Door, 4 Pcs. NEW	11620.10
Flat Fender Flare & Liner Kit, 2007-12 Wrangler, 8 Pcs. NEW	11620.11

*includes side marker light relocation brackets

ALL TERRAIN FLAT FLARE WHEEL LINER KIT

Designed for use in combination with the Rugged Ridge All Terrain Flat Flares for JK, PN: 11620.10, these wheel well liners help keep mud and debris out of the engine compartment and provide a clean finished look. Constructed from durable HDPE, the wheel liners replace the factory wheel well liners that must be removed when running aftermarket flares. Simple bolt in installation, no cutting or drilling required. Kit includes all four wheel well liners and mounting hardware.



Flare Wheel Liner Kit

	Part #
2007-12 Wrangler, 4 Pcs. NEW	11620.50

REPLACEMENT FENDER FLARE KITS

Rugged Ridge® provides the most comprehensive replacement Fender Flare program on the market today. Rugged Ridge® has you covered when it is time to replace or upgrade your Factory Fender Flares. Each Flare is constructed of virtually indestructible, durable, UV treated thermoplastic to provide years of service. Each replacement flare is designed to fit into your factory mounting holes for ease of installation. Just need to replace one flare? No problem. Rugged Ridge® offers individual replacements to keep your investment to a minimum.



Fender Flare Kits	Complete Kit 4-pc kit w/out hardware	Front Passenger	Front Driver	Rear Passenger	Rear Driver
07-12 Wrangler*	11609.01	11609.10	11609.11	11609.12	11609.13

*Except Sahara

All images are subject to be representative. More detailed information is available online.

Wheels For 2007-12 Wrangler



15301.10 Satin Black with Machined Lip



15301.01 Satin Black



15301.40 Silver



15301.20 Chrome



15301.10

Rugged Ridge® is proud to introduce the toughest new design in custom wheels for 2007-12 Wrangler. This Hub-Centric design exactly centers the wheel over the hub providing proper balance, clearance for brake rotors, steering components and suspension. Better fit, no wheel vibration! Stainless steel button-head socket cap screws around the perimeter of the outer wheel face give a great 3-piece look, and also let you accessorize with our optional trim ring. Each wheel includes a UV-treated polished center cap that replicates a manual hub for that off road look. Available in five finishes: Satin Black Powdercoated, Satin Black Powdercoated with Machined Lip, Silver Powdercoated, Dual-Stage Polished Chrome, and Limited Edition Hyper Silver. The durable powdercoated finish gives an ultra-hard finish for long life and a great look. The chrome finish uses a dual-stage process to give a deep reflective mirror-like shine that commands attention. Rugged Ridge® wheels have been independently tested and certified to meet/exceed SAE J2530 standards for wheel strength and durability. Limited lifetime structural warranty and 1 year finish warranty [see warranty information for details and limitations].



15301.20

Rugged Ridge® Aluminum Wheels for 07-12 Wrangler

	Part #
Rugged Ridge® Wheel, 17"x9", 12mm Offset, 4.625" Backspacing, Satin Black	15301.01
Rugged Ridge® Wheel, 17"x9", 12mm Offset, 4.625" Backspacing, Satin Black w/Machined Lip	15301.10
Rugged Ridge® Wheel, 17"x9", 12mm Offset, 4.625" Backspacing, Silver	15301.40
Rugged Ridge® Wheel, 17"x9", 12mm Offset, 4.625" Backspacing, Chrome	15301.20
Center Cap, Replacement Part for 17"x9" Aluminum Rugged Ridge® Wheel	15201.50

STEEL D-WINDOW WHEELS



Legendary looks, brutally epic strength. Each Rugged Ridge® steel wheel is stamped from heavy gauge steel and powder coated with a durable black finish. Our wheels have been engineered, tested and certified to meet and exceed the strenuous SAE J2530 standards for wheel strength and durability. Turning a million cycles at double their load capacity to ensure they could hold up the abuses of off road use. Because a Jeep® isn't a Jeep® until its lifted and outfitted with oversized tires. All Rugged Ridge® Steel D Window wheels include a FREE polished center cap!

Steel D-Window Wheels

	Part #
07-12 Wrangler, Black, 17X9, 5 on 5 Bolt pattern, 4.5 Backspacing NEW	15500.70

RIM PROTECTORS

Trim rings are available in either Satin Black Powdercoated or Polished Stainless Steel. These trim rings are a great way to protect the wheel lip and tire bead. They also allow you to change the look of your wheels with just a few bolts. For use with Rugged Ridge® wheels only.



15250.02 Rim Protector
Satin Black for 17"x9" Wheel

Rugged Ridge® Rim Protectors for Rugged Ridge® Wheels Only

	Part #
07-12 Wrangler, Rugged Ridge® Rim Protector, 17"x9", Polished Stainless Steel *	15250.01
07-12 Wrangler, Rugged Ridge® Rim Protector, 17"x9", Satin Black *	15250.02

* Will not fit 15301.20

WHEEL SPACER & ADAPTOR KITS



15201.05



15201.07



15201.06

These hub centric spacers / adapters move your wheels out to help fit wider tires and give your vehicle a wider track and improve stability. Constructed of double anodized black extra thick 6061T6 aluminum for long life and extra corrosion resistance. All hardware is grade-8 for extra strength. Each part number comes as a spacer pair. Included are 10 pre-installed grade-8 wheel studs and 10 lug nuts.

Wheel Spacer Kit

		Part #
07-12 Wrangler, Pair	1.5" Spacer	15201.05
07-12 Wrangler, Pair *	1.375" Adapter	15201.06
07-12 Wrangler, Pair **	1.375" Adapter	15201.07

* converting 5 on 5" to 5 on 4.5" bolt pattern
** converting 5 on 5" to 5 on 5.5" bolt pattern

CAUTION!

CAUTION: Rugged Ridge® recommends use of wheel spacers with all suspension lifts to reduce risk of roll over or other accident associated with modifying ride height for increased off road capabilities. See additional product safety information and WARNINGS at back of catalog.

All images are subject to be representative. More detailed information is available online.

NEW POWER TOP

BY RUGGED RIDGE®

The first true convertible top for 07-12 Wranglers



POWER TOP AUTOMATICALLY GOES UP AND DOWN WITH THE PUSH OF A BUTTON!



Rugged Ridge® is excited to announce the first ever true convertible top for the 4 door JK Jeep® Wrangler. No more struggling to get your soft top up and down. This revolutionary soft top design automatically goes up and down without you even getting out of the vehicle. Our patent pending design allows the top to be lowered or raised in seconds by unlatching two header latches and the simple push of a button! In development for over a year, the engineers at Rugged Ridge® have created a heavy duty frame system that folds up and over your factory roll bar therefore making the "push button" design possible. The Power Top Kit fits all 2007-2012 four door Wranglers and comes complete with heavy duty sailcloth fabric, 31% tint 30 mil rear window glass, power top frame, hydraulics, wiring harness and an in-depth installation packet. Everything you need to make your JK a true convertible top!

NEW!



Each Power top is a complete kit that includes everything you need for installation to your 2007-2012 four door Wrangler: heavy duty sailcloth fabric, 31% tint 30 mil rear window glass, power top frame, hydraulics, motor, wiring harness and an in-depth installation packet. Bolt-on installation, No fabrication necessary.



WARNING:

Loss of vehicle control involves risk of death or serious injury, particularly to parts of your body not restrained within vehicle. This product is intended for weather protection only and should not be relied upon to contain occupants in the event of an accident or to protect from either ground contact or falling objects. To reduce risk of accident injury:
 - Always wear seat belts.
 - Read and follow all instructions and warnings accompanying this product, in vehicle owners manual and Off Road Driving Supplement.

THE POWER TOP WILL FOREVER
CHANGE THE WAY SOFT TOPS FOR
JEEPS® ARE DESIGNED



Wrangler 07-12

LOOK AT THESE EXCLUSIVE FEATURES:

- The kit has everything needed for a complete installation including the soft top, frame, door surrounds, motor, hydraulics and wiring. Installation requires that you reuse the factory header and rear tailgate bar. One kit fits all years of 4 door Wrangler!
- Professional installation is recommended but a skilled do it yourselfer can also install it and no special tools are required. **Estimated install time for a skilled installer is approximately 5 hours.**
- The [patent pending] 4 door version will be available first but we also have a 2 door version in development.
- The frame comes pre-assembled and ready for installation and is constructed from corrosion resistant powder coated steel. All fasteners and bushing are specified for high grade strength and wear resistance.
- The frame installs to the tub rail using pre-existing holes along the top and then one hole is required over either wheel well on both sides to provide added support for strength, rigidity and smooth operation.
- Injection molded door surrounds are included to replace the factory surrounds to ensure a weather tight seal.
- The frame is powered by an electric motor with a hydraulic pump that drives two hydraulic cylinders. The motor and wiring relays mounts underneath the rear deck lid where it is concealed neatly out of the way.
- The motor and hydraulic cylinders come pre-assembled and ready to install with adjustable flow control valve, hoses, fittings and fluid [pre-bled].
- The top is constructed from premium sail cloth fabric and includes a zip-out removable DOT approved 30 mil rear window with 31% smoke tint.
- The system includes all wiring, relays, and switches for a complete installation. The wiring scheme is a simple yet very effective design and protects against improper operation or damage of the top by only working when the drivers' foot is on the brake.
- Limit switches are also included to control the power when the top is either fully up or fully down for added safety and to reduce wear and stress on the system.
- Operation of the top is extremely easy and effortless. From the driver's seat you simply unlatch the header and [while your foot is on the brake and key in ignition] push the switch. Down it goes! That's it!
- The power top is designed to stay on the vehicle full time once it is installed. However, it can also be removed from time to time if necessary thus permitting the owner to change it over to their hard top in winter or to return the vehicle to a factory style top.
- Service and replacement parts will be readily available.
- The entire system and all components are covered by our 3 year warranty.



A durable hydraulic piston provides the torque to lift and retract the Power Top. Easily secured to the vehicle wheel well and soft top frame, this durable component has been cycle tested to ensure a long life and consistent performance.



The Name Power Top comes from a durable electric power plant that has been specially developed for strength and size. This heavy duty motor installs in the storage compartment in the rear of your Jeep® keeping the rear cargo area clutter free. Each Power top includes the necessary wiring harness to make installation as easy as possible.



All Power tops have a tinted rear window that either rolls up or can be completely zipped out. This allows for that open air experience that Jeep® owners love! All Window glass is extra thick 30mil DOT approved with 31% tint. Quality and superior function all in one!

Power Top

Power Top Kit, Black Sail Cloth, Jeep® Wrangler [JK] 4-Door 2007-2012

* 2 Door JK is planned for 2012 introduction

Part#

13515.01

All images are subject to be representative. More detailed information is available online.

XHD FABRIC REPLACEMENT SOFT TOPS

Rugged Ridge® soft tops use only the finest vinyl coated polyester & sailcloth fabrics on all their tops. Each fabric color is specially formulated to match the original equipment colored top to make your Jeep® look like it came off the show room floor. These fabric only soft tops are designed to fit over your original factory hardware

NEW!

Wrangler 07-12



Fabric Replacement Tops for JK

	Diamond Black	Diamond Khaki
Without Door Skins, Jeep® Wrangler [JK] 07-09 2-Door NEW	13736.35	13736.36
Without Door Skins, Jeep® Wrangler [JK] 07-09 4-Door NEW	13741.35	13741.36

Sailcloth Fabric Replacement Tops for JK

	Black Diamond	
Sailcloth, With Tinted Windows, Without Door Skins, Jeep® Wrangler [JK] 07-09 2-Door NEW	13736.01	-
Sailcloth, With Tinted Windows, Without Door Skins, Jeep® Wrangler [JK] 07-09 4-Door NEW	13741.01	-

POCKET BRIEFS

Tired of papers and other small items flying around the cab of your Jeep® when using your Summer Brief? Introducing the most innovative new addition to a Summer Brief in over 50 years the Pocket Brief from Rugged Ridge®! This revolutionary design incorporates two mesh zippered corner pockets directly over the driver and passenger creating much needed storage space. Special two sided mesh and nylon "pocket" seals shut with a reinforced zipper, keeps small items secure even in most severe conditions. Built directly into the Rugged Ridge® Summer Brief to ensure a clean, tight fit. Constructed of durable soft top fabric for long life. Available in matching soft top colors to give your Jeep® a finished look.



NEW!



Pocket Brief

	Diamond Black	Diamond Khaki
Pocket Brief 07-09 Wrangler, 2-Door & 4-Door*	13587.35	13587.36
Pocket Brief 10-12 Wrangler, 2-Door & 4-Door* NEW	13590.35	13590.36

* Requires a separate Windshield Header (#13308.05) for installation

MESH SUMMER BRIEFS/ISLAND TOPPERS™



Mesh Summer Briefs Include Corner Pockets

Special UV treated mesh fabric blocks the heat while allowing the cool breeze to flow through. The special weave of the Rugged Ridge® mesh brief/Island Topper is designed for strength and durability while providing open air protection from the sun's heat. Available in two great styles: the Summer Brief that goes to the center hoop and the "Island Topper" that goes back to cover those rear seat passengers. Don't forget the Header/Windshield channel needed to install these tops!

Mesh Summer Briefs/Island Topper™

	Part #
Mesh Summer Brief, 07-09 Wrangler 2-Door, Each *	13579.02
Mesh Summer Brief, 10-12 Wrangler 2-Door, Each* NEW	13579.12
Mesh Summer Island Topper, 07-09 Wrangler 2-Door, Each *	13579.01
Mesh Summer Island Topper, 10-12 Wrangler 2-Door, Each* NEW	13579.11
Mesh Summer Island Topper, 07-09 Wrangler 4-Door, Each *	13579.03
Mesh Summer Island Topper, 10-12 Wrangler 4-Door, Each* NEW	13579.13

* Requires a separate Windshield Header (#13308.05) for installation

POCKET ISLAND TOPPERS™



13588.35 Island Topper, Diamond Black, 07-09 Wrangler



NEW!

Pocket Island Toppers feature zippered pockets to securely stow away important items like cell phones, maps and sunglasses.

The most advanced summer soft top solution found on the market today, the new Pocket Island Topper! This new design features tough diamond fabric combined with a pair of zipper front pockets for the ultimate full featured top. Unlike other summer tops on the market, the Rugged Ridge® design features wider side hook and loop fastener straps, a reinforced front section and extra heavy duty nylon tie down straps.

Pocket Island Toppers	Diamond Black	Diamond Khaki
10-12 Wrangler, 2-Door * NEW	13591.35	13591.36
10-12 Wrangler, 4-Door * NEW	13592.35	13592.36
07-09 Wrangler, 2-Door *	13588.35	13588.36
07-09 Wrangler, 4-Door *	13589.35	13589.36

* Requires a separate Windshield Header (#13308.06) for installation

WINDSHIELD HEADERS

These upgraded preassembled windshield headers installs quickly and easily! Just attach your Brief/Island Topper and place the header channel on the top of your windshield, slide the clamps onto the supplied knobs and clamp the channel in place. That's it! The channel is now securely held in place and ready for summer wheeling. No drilling or modifications required! Note: Will work with Bestop and other aftermarket summer tops. No Drill Windshield Header required for installation of Pocket Briefs and Island Toppers on all 07-12 Wranglers.



NEW!



Windshield Header	Part #
07-12 Wrangler, Extruded Aluminum, 2 & 4-Door	13308.05
07-12 Wrangler, Deluxe, 2 & 4-Door, Stamped Steel* NEW	13308.06

*For use with Summer Briefs, Island Toppers and all other brands of summer tops

WARNING: Loss of vehicle control involves risk of death or serious injury, particularly to parts of your body not restrained within vehicle. This product is intended for weather protection only and should not be relied upon to contain occupants in the event of an accident or to protect from either ground contact or falling objects. To reduce risk of accident injury:

- Always wear seat belts.
- Read and follow all instructions and warnings accompanying this product, in vehicle owners manual and Off Road Driving Supplement.

All images are subject to be representative. More detailed information is available online.

WINDOW STORAGE ROLL BAG

Protect your soft top windows from scratching and other damage with a window storage bag from Rugged Ridge®. This easy to use storage bag stores your rear quarter and rear back window using a soft internal material and a heavy duty exterior fabric bag for the ultimate in protection. The internal fabric is placed between the windows to prevent scratching and window on window contact. Simply place the windows in between the fabric and gently roll the windows into an easy to store "window roll". This rolled up bag can now be easily installed to the rear of your sport bar with attached nylon straps and buckles. This window storage bag solution is a must for those soft top owners who want to keep their windows out of harm's way and prolong the life of their soft top. Each storage bag is backed by an industry leading 3 year limited warranty.



Window Storage Sport Bar Bag	Part #
Black, Jeep® Wrangler (JK) 07-12, 2-Door or 4-Door NEW	12107.05



JK SOFT TOP STORAGE BOOT

Want to cruise around with the top off, but keep your top close in case of sudden showers or temperature drops? The Rugged Ridge® Soft Top Storage Boot is the solution to protect your soft top when it is folded down. Designed to be used with the windows zipped out.

JK Soft Top Storage Boot	Part #
07-12 Wrangler 2-Door, Black Diamond, Each	12104.50
07-12 Wrangler 4-Door, Black Diamond, Each	12104.51

SOFT TOP DISCONNECTS

Upgrade your factory 2007-12 Wrangler Soft Top Hardware with these quick release bow mounts. Allows for easy, no tool disconnect of your soft top bows from your Jeep®. Installation is easy and quick, no drilling required.



Soft Top Disconnect Kit	Part #
07-12 Wrangler 4-Door, 4 pack	11251.04

TIRE COVERS

Custom designed to fit today's most popular sized tires. Constructed of durable vinyl coated polyester fabric. Colors match other Rugged Ridge® Soft Accessories. Please measure tire diameter.

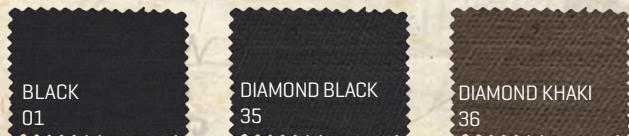

Tire Diameter	Black	Diamond Black	Diamond Khaki
27-29"	12801.01	12801.35	12801.36
30-32"	12802.01	12802.35	12802.36
33"	-	12803.35	-
35-36"	-	12804.35	-



Note: To ensure proper fit, measure the diameter of the tire you are covering and pick the appropriate tire cover size listed above.

HARD TOP SOUND DEADENER/INSULATION FOR 2007-12 WRANGLER

If you chose the Hard Top option for your 07-12 Wrangler then you need Rugged Ridge®'s Sound Deadener. This insulation is custom fit for the factory multi-piece hard top and greatly reduces noise inside your vehicle. The special insulation material is surrounded by heavy duty pleated nylon providing added interior comfort by insulating the cab from heat and cold. A no drill installation with durable hook and loop fasteners allows for an easy installation without removing your hard top.



Sound Deadener for 07-12 Wrangler Hard Top

	Part #
07-10 Wrangler 2-Door, 3 pcs. NEW	12109.01
07-10 Wrangler 4-Door, 4 pcs. NEW	12109.02
11-12 Wrangler 2-Door, 3 pcs. NEW	12109.03
11-12 Wrangler 4-Door, 4 pcs. NEW	12109.04



NEW!

WATER RESISTANT CAB/FULL COVERS

Custom fit Cab Covers protect your vehicles interior from dust, dirt and light showers. Constructed of vinyl coated polyester fabric or a space age cover material [Weather Lite/Three Layer Covers], these easy to use covers install in minutes. Reinforced elastic side straps and under body hooks hold the cab cover in place. No drilling required. Complete vehicle covers also available in breathable Weather Lite fabric or durable Three Layer Fabric. Weather Lite is perfect for inside storage while the Three Layer covers are designed for short term outdoor use.

3 LAYER PROTECTION!

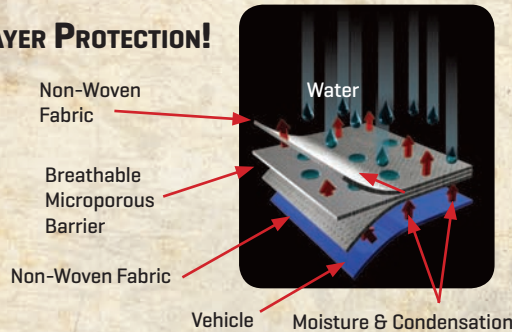

Full Covers

	Part #
Three Layer Full Car Cover (w/Bag & Lock) 07-12 4-Door Wrangler	13321.73
Three Layer Full Car Cover (Cover only) 07-12 4-Door Wrangler	13321.71
Three Layer Full Car Cover (w/Bag & Lock), 07-12 2-Door Wrangler	13321.81
Three Layer Full Car Cover (Cover only), 07-12 2-Door Wrangler	13321.80
Car Cover Storage Bag	12105.01
Cab Cover, Weather Lite, 07-12 2-Door Wrangler NEW	13317.10
Cab Cover, Weather Lite, 07-12 4-Door Wrangler NEW	13318.10
Cab Cover, Vinyl, 07-12 2-Door Wrangler NEW	13317.09
Cab Cover, Vinyl, 07-12 4-Door Wrangler NEW	13318.09



NEW!



Complete Cover kits with lock and storage bag available.

All images are subject to be representative. More detailed information is available online.

RUGGED RIDGE® ALL TERRAIN FLOOR LINERS FOR 07-12 WRANGLER

The only floor liner with patented "Deep Tread" Technology!

These floor liners are a totally new concept that combines all the best features of a deep rib floor mat and the 'old style' liners. Precision engineering using state of the art technology ensures an exact fit to the shape and contour of your vehicle's floor. The deeply molded Chevron-shape tread pattern channels dirt, mud and snow away from the driver to keep shoes and pant legs clean. It also contains the movement and sloshing around of any trapped water. The high perimeter wall offers a large footprint and maximum interior protection and containment. Unlike ordinary liners that utilize an inconsistent vacuum thermoform process and slippery lower grade plastic these liners are high pressure injection molded from OE-quality Thermoplastic that looks and feels like rubber and provides a nonslip surface. Raised ribs on the bottom provide maximum retention and keep the liner in place. The unique self-sealing floor hook attachment feature helps to prevent dirt and moisture from getting through. Easy to remove and clean. Simply hose them off and go!!! The mat actually reseals itself around the hook!!! Patent D627285.



2nd Row, Jeep® 07-12 Wrangler 4-Door

Rugged Ridge® Floor Liners & Cargo Liners	Part #
Floor Liner, Front, 2 and 4-Door 07-12 Wrangler, Pair	12920.01
Floor Liner, Rear, 4-Door 07-12 Wrangler, One Piece Design	12950.01
Floor Liner, Rear, 2-Door 07-12 Wrangler, Pair	12950.02
Cargo Liner, 2 and 4-Door 07-10 Wrangler	12975.01
Cargo Liner, 2 and 4-Door 11-12 Wrangler, NEW	12975.03
Floor Liner Kit, Front and Rear, 07-12 Wrangler 4-Door	12987.01
Floor Liner Kit, Front and Rear, 07-12 Wrangler 2-Door	12987.02



Self-sealing floor hook attachment feature helps to prevent dirt and moisture from getting through. The mat reseals itself around the hook!

The deeply molded Chevron shape tread pattern channels dirt, mud and snow away from the driver to keep shoes and pant legs clean. "Deep Tread" technology!

The high perimeter wall offers a large footprint and maximum interior protection and containment.



Jeep® 07-12 Wrangler 2-Door & 4-Door

Easy to clean design; simply hose off and go!





RUGGED RIDGE® SUN VISOR COVERS FOR 2007-12 JEEP® WRANGLER

Instantly turn those plastic factory sun visors on your 2007-2012 Wrangler into usable storage space while getting a clean new look with Custom Rugged Ridge® Visor Covers. Each pair of visor covers quickly and easily attach to your factory sun visors without drilling or vehicle modification. Constructed of durable interior matching textured black vinyl, these covers will provide the storage and features you want while looking great. The driver's side cover features a see through bottom window to expose the factory warning labels and an inside storage pocket with custom storage options; two pen/tire gauge holders, clear window registration/insurance card holder, Mesh storage pocket for commonly used items like garage door openers and a cavernous fold down storage pocket that can hold CD's and cell phones. The passenger side cover offers the same cavernous storage pocket as the driver's side (great for road maps!) but also features a vanity mirror. Packed as drivers' and passenger set, these great covers are the perfect add on accessory for your Jeep®! Note: 2007-09 Visor Covers will not interchange with 2010-2012 Wranglers due to factory visor change.

Rugged Ridge® Sun Visor Covers

Part #

07-09 Wrangler NEW	13305.07
10-12 Wrangler NEW	13305.08

RUGGED RIDGE® OVERHEAD STORAGE CONSOLE FOR 2007-12 JEEP® WRANGLER



The Rugged Ridge® Overhead Storage Console is the storage solution you have been waiting for! It instantly turns the area underneath your top into usable storage space without any interference or modification to your vehicle. Fits all 2007-2012 Jeep® Wranglers! Works with soft tops, hardtops, the top up, or the top down. The Overhead Storage Console is a fully enclosed storage compartment that installs easily without any tools or drilling. It is constructed from durable blow molded High-Density polyethylene (HDPE), so it is safer and lighter than steel. A non-skid pad is adhered to the inside of the console to help keep your gear from sliding around, and a mesh storage net helps keep it safely stowed yet easily accessible. The console measures 41.5"x2.5"x6.5" and offers more than 450 cubic inches of storage.

Rugged Ridge® Overhead Storage Console

Part #

07-12 Wrangler NEW	13551.14
---------------------------	----------



DASH ORGANIZER FOR 2007-10 WRANGLER

Looking for space to store that clutter? Introducing the new Rugged Ridge® Dash Organizer for 2007-2010 Jeep® Wranglers! This innovative new product incorporates existing mounting points to install a dual tray storage system right on your dash. Now you can easily store coins, pens, sunglasses, cell phones and other small items right in reach of both the passenger and driver. Installation is a snap; simply remove the original equipment screw covers on your dash, screw in the exclusive double headed mount and attach the Dash Organizer. It is that easy! Each Dash Organizer incorporates UV treated thermoplastic mounts and two trays with a painted aluminum cross tube for the ultimate in flexible design. Each tray can be mounted across the aluminum tube with thumb screw attachments. Rubber feet attached to the trays prevent rattling and provide a secure fit. The small tray has a special built in slot for MP3 players or cell phones with a belt clip (not included). Each tray has a special "recessed guide" that can be easily drilled out to create an out-of-the-way power cord locator. This exciting design has a low profile and does not interfere with driver visibility or air bag deployment.



Rugged Ridge® Organizers

Part #

Dash Organizer, 07-10 Wrangler	13551.10
--------------------------------	----------

*will not fit 2011-2012 models

Each Dash Organizer also includes a split bracket CB mounting kit and separate CB microphone holder for use with most smaller CB units. Holes in the bottom of the large tray have been pre-drilled for easy installation of these brackets and include a recessed area for optional out-of-the-way power cord use.

REAR STORAGE BIN FOR 2007-10 WRANGLER

Protect your carpet from moisture, dirt, and grease with the exclusive Rugged Ridge® storage bin for 07-10 Wrangler. This custom fit storage bin fits perfectly in the rear cargo area storage compartment providing protection and an easy to use removable tote. Molded from rigid and durable ABS plastic for a perfect contoured fit and long life. The unique chevron pattern matches the look of the All Terrain Floor and Cargo Liners. Each bin features integrated handles for ease of removal and cleaning.

Rugged Ridge® Storage Bin	Part #
Rugged Ridge® Storage Bin, 07-10 Wrangler	13122.01



TRAIL BAGS

Rugged Ridge® has the answer for your onboard storage needs. These soft-side storage bags feature heavy canvas construction and oversized zippers. Great for carrying recovery gear, spare parts, camping gear, clothes, or any other necessity for a wheeling trip. Rugged nylon straps keep the bags in place during even the most insane wheeling. Make the most out of your roll cage with a full complement of Rugged Ridge® storage bags. These bags are easy to install and take off and work with both hard tops and soft tops.



Trail Bags	Part #
Seat Back Trail Bag, Detachable, 07-12 Wrangler, Each	13551.25
Seat Back Trail Bag, 07-12 Wrangler, Each	13551.26
Sport Bar Trail Bag, Canvas Storage Bag, 07-12 2-Door Wrangler, Each	11250.06
Sport Bar Trail Tube Bag, 07-12 Wrangler, Each	11250.05

JK REAR SEAT ORGANIZER

The perfect organization solution for your Jeep®! The new Rugged Ridge® Back Seat Organizer features two separate storage areas to organize wayward trash, toys, drinks, iPods and other clutter. Each organizer is designed to instantly fit into the rear cup holders of your 2007-10 Jeep® Wrangler and includes a removable double walled lid. The large storage area will hold up to three 12oz. soda cans or two 16.9oz. water bottles with ice. The top lid can be easily removed creating a handy writing surface or small tray. The front tray can keep cell phones, iPods or other small items from rolling around the back seat. Easily removable to clean and empty, this truly is a must for your Jeep®!

JK Rear Seat Organizer Description	Part #
Rear Seat Organizer, Jeep® Wrangler [JK] 07-10 NEW	13551.15

*will not fit 2011-2012



SUNGLASS HOLDER/ROLL BAR STORAGE

Another perfect organization solution for your Jeep®! Allows you to stow your sunglasses, wallet, GPS, or other small accessories within arms reach. A perfect size zipper storage pouch allows for added storage right where you need it. Attaches easily to your sport bar using hook and loop fasteners-no drilling required



Sunglass Holder	Part #
All Jeep® Wranglers NEW	12101.52

NEW!

CUSTOM FIT NEOPRENE SEAT COVERS



13214.53 Front Seat Covers
Neoprene, 07-10 Wrangler

Protect your Jeep's® interior with these Custom Fit Neoprene Seat Covers from Rugged Ridge®. These covers are constructed of durable 100% neoprene with no filler fabrics creating the best fitting, longest lasting neoprene seat cover available. Neoprene [wetsuit material] is a great fabric to protect your seats from dirt, water and whatever mother nature can throw at you! Each cover is custom tailored for your Jeep's® original equipment seat style making your seats look like they have been recently reupholstered.

Installation is easy with special designed elastic cords, nylon straps and hooks that attach to your seat and to the seat cover mounting points. All seams have been double reinforced for strength and a special backing fabric is used on the seams for added protection against rips and tears. Available in black on black, gray on black, red on black and tan on black to complement virtually any Jeep® interior.

Custom Neoprene Seat Covers	Black/ Black	Black/ Gray	Black/ Red	Black/ Tan
Front, 07-10 Wrangler with or without Side Airbags, Pair	13214.01	13214.09	13214.53	-
Front, 2011-12 Wrangler with or without Side Airbags, Pair NEW	13215.01	13215.09	13215.53	13215.04
Rear, 07-12 Wrangler 4-Door, Pair NEW	13264.01	13264.09	13264.53	13264.04
Rear, 07-12 Wrangler 2-Door, Pair NEW	13265.01	13265.09	13265.53	13265.04

13264.53



Rear Seat Covers, Neoprene, 07-12 Wrangler,
Includes Separate Headrest Covers



13264.09



13214.01
Front Seat Covers,
Neoprene, 07-10 Wrangler, Includes
Separate Headrest Covers

All images are subject to be representative. More detailed information is available online.

NEOPRENE SEAT PROTECTORS FOR 2007-12 WRANGLER

Protect your seats from the elements, wet bathing suits and spills while providing a great look. Each set of seat protectors includes back pockets for rear storage as well as a removable cup holder. Cushioned center portion gives the Seat Protector a great look and provides you extra comfort on those long road trips. New solid color design further enhances the look of your Jeep®.



Lots of Extra Storage



13235.20 Seat Protector, Black, 07-12 Wrangler



07-12 Wrangler Neoprene Seat Protector

With Factory Side Air bags, Pair

Black	Gray	Tan
13235.30	13235.32	13235.21

ARM REST PAD FOR 2007-10 WRANGLER



Black / Gray Neoprene Model



Black Diamond Vinyl Model

Rugged Ridge®'s Patented Arm Rest Pad bolts directly into existing JK mounting screws-no need to remove the OE lid. Steel brackets ensure durability. Uses either Neoprene or tough vinyl coated polyester fabric with a dense foam center for comfort, performance and a great look in the vehicle. Allows for full opening and closing of the console lid. No drilling required.

Arm Rest Pad For 07-10 Wrangler	Part #
Black Diamond Vinyl, Each	13107.35
Black/Gray Neoprene, Each	13107.09
Black Neoprene, Each	13107.01

CENTER CONSOLE ARMREST PAD

This easy to use arm rest pad/cover from Rugged Ridge® provides protection and comfort all in one! Constructed of heavy duty neoprene (wet suit material) with an added layer of padding for the arm rest, this slip on cover provides an extra soft place to put your arm while driving. Since it covers the entire top of the arm rest, this cover also provides added arm rest protection from pet claws, dirt and sticky fingers. Installation is easy with an elastic band; no drilling or tools required. Black Neoprene compliments your vehicle's interior and will match custom fit Neoprene seat covers. Limited three year warranty.

NEW!



Center Console Armrest Pad

Part #

11-12 Wrangler, Black, Neoprene **NEW**

13108.01

SUV/JEEP® STORAGE BAG

Custom designed to provide removable storage for Jeep® vehicles. Special size fits behind rear seat to organize and store your cargo. Constructed of durable vinyl with a zipper top and removable cargo dividers - easy to use shoulder strap included.



Off-Jeep®/SUV Storage Bag

Part #

Universal all Jeep®

13551.01

OFF-ROAD ORGANIZER

Custom design for use in Jeep® glove boxes. Special pockets allow you to effectively organize owners manuals, maps, tire gauges, vehicle registration and more. Constructed of durable nylon in a tri-fold configuration.



Off-Road Organizer

Part #

Universal

13305.06



BILLET INTERIOR TRIM & UNDER HOOD GARNISH FOR 2007-2011 WRANGLER

Enhance the appearance of your Jeep® with these premium CNC machined billet aluminum accessories from Rugged Ridge®. Available in a lightly brushed or black anodized finish. These high quality accessories replace your factory components with no drilling or modification. The easy installation allows you to upgrade your interior in minutes with simple hand tools!

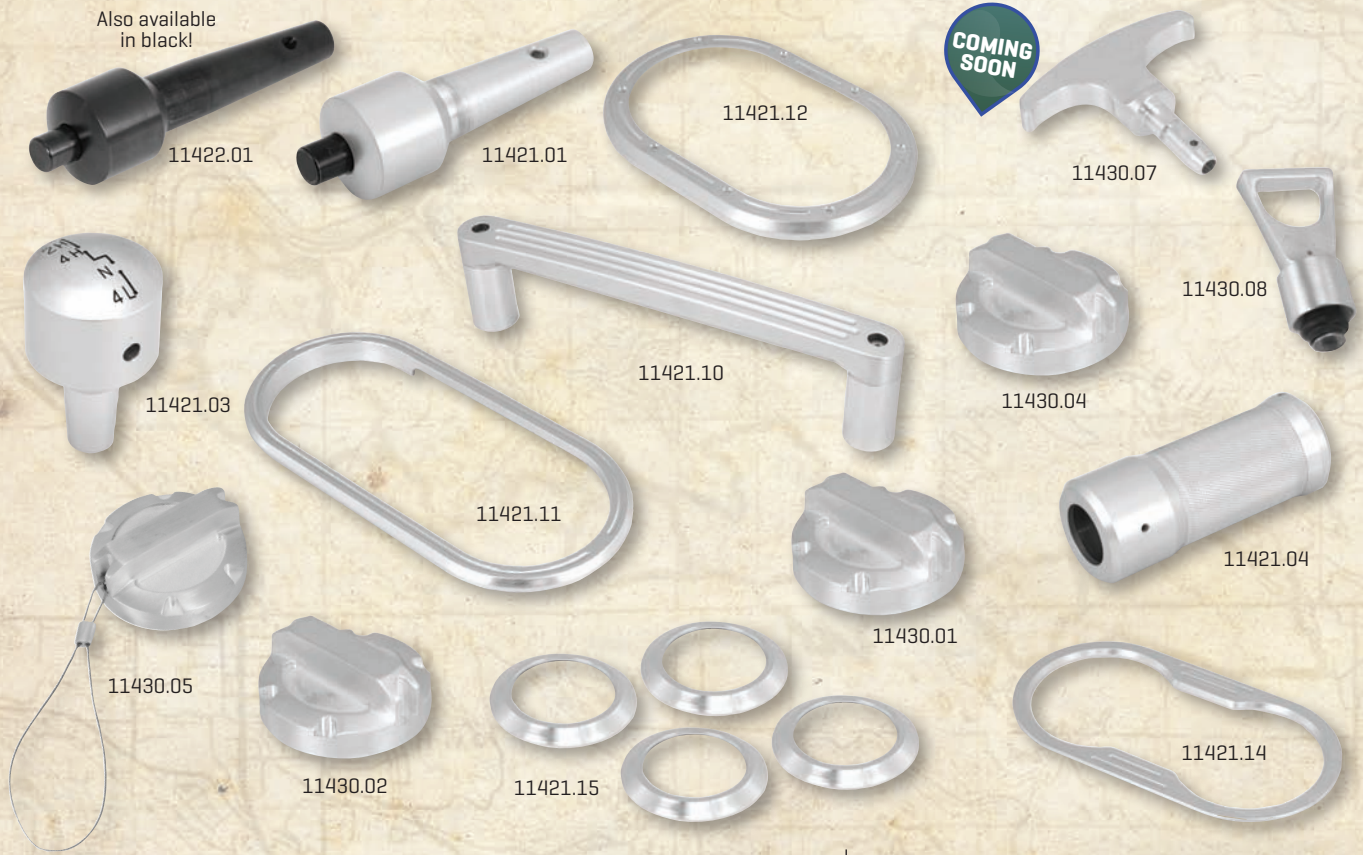

Also available in black!

COMING SOON

Wrangler 07-12



11421.02

Billet Aluminum Components COMING SOON!

- Wrangler 07-10, Automatic Transmission Shifter Knob, Billet Aluminum
- Wrangler 07-10, Manual Transmission Shifter Knob, Billet Aluminum
- Wrangler 07-10, Transfer Case Shifter Knob, Billet Aluminum
- Wrangler 07-10, Emergency Brake Handle Cover, Billet Aluminum
- Wrangler 07-10, Passenger Grab Bar Handle, Billet Aluminum
- Wrangler 07-10, Automatic Transmission Shifter Bezel, Billet Aluminum
- Wrangler 07-10, Manual Transmission Shifter Bezel, Billet Aluminum
- Wrangler 07-10, Cup Holder Bezel, Front, Billet Aluminum
- Wrangler 07-10, AC Vent Bezels, Set of Four, Billet Aluminum
- Wrangler 07-11, Power Steering Cap, Billet Aluminum
- Wrangler 07-11, Brake Master Cylinder, Billet Aluminum
- Wrangler 07-11, Oil Cap, Billet Aluminum
- Wrangler 07-11, Washer Fluid Cap, Billet Aluminum
- Wrangler 07-11, Oil Dipstick Handle, Billet Aluminum
- Wrangler 07-11, Automatic Transmission Dipstick Handle, Billet Aluminum

Brushed Aluminum

Black

	Brushed Aluminum	Black
Wrangler 07-10, Automatic Transmission Shifter Knob, Billet Aluminum	11421.01	11422.01
Wrangler 07-10, Manual Transmission Shifter Knob, Billet Aluminum	11421.02	11422.02
Wrangler 07-10, Transfer Case Shifter Knob, Billet Aluminum	11421.03	11422.03
Wrangler 07-10, Emergency Brake Handle Cover, Billet Aluminum	11421.04	11422.04
Wrangler 07-10, Passenger Grab Bar Handle, Billet Aluminum	11421.10	11422.10
Wrangler 07-10, Automatic Transmission Shifter Bezel, Billet Aluminum	11421.11	11422.11
Wrangler 07-10, Manual Transmission Shifter Bezel, Billet Aluminum	11421.12	11422.12
Wrangler 07-10, Cup Holder Bezel, Front, Billet Aluminum	11421.14	11422.14
Wrangler 07-10, AC Vent Bezels, Set of Four, Billet Aluminum	11421.15	11422.15
Wrangler 07-11, Power Steering Cap, Billet Aluminum	11430.01	11431.01
Wrangler 07-11, Brake Master Cylinder, Billet Aluminum	11430.02	11431.02
Wrangler 07-11, Oil Cap, Billet Aluminum	11430.04	11431.04
Wrangler 07-11, Washer Fluid Cap, Billet Aluminum	11430.05	11431.05
Wrangler 07-11, Oil Dipstick Handle, Billet Aluminum	11430.07	11431.07
Wrangler 07-11, Automatic Transmission Dipstick Handle, Billet Aluminum	11430.08	11431.08

BILLET ALUMINUM CLIMATE CONTROL KNOBS

Billet aluminum Wrangler Climate Control Knobs. These stylish knobs are easily installed by pulling off the factory knobs and pushing these back in their place. Choose red or blue colored inserts in the face of the knobs to illuminate at night and show their position.



Billet Aluminum Climate Control Knobs

	Part #
07-10 Wrangler/Unlimited, Blue Indicator Lights, Set of 3	11420.05
07-10 Wrangler/Unlimited, Red Indicator Lights, Set of 3	11420.06

All images are subject to be representative. More detailed information is available online.

BRUSHED SILVER/CHROME INTERIOR TRIM FOR 2007-10 WRANGLER



Make your 07-10 Wrangler unique with Rugged Ridge® interior accents. These injection-molded plastic accents are molded directly from the factory interior pieces for an exact fit. Installation is a snap thanks to the pre-installed high-strength adhesive tape. Available in brushed silver (matches factory Rubicon interior trim pieces) or chrome finish.



11151.01 Brushed Silver Shifter Trim



11151.10 Brushed Silver AC Vent Trim



11156.10 Chrome AC Vent Trim

2-Door Kits include: accents for Shifter, AC Vent Covers, Tweeter Speakers, Steering Wheel, Front Clip Holder, Dash Panel, Grab Handle, Front Door Handles, and Front Door Pulls.

4-Door Kits include: all the accents in the 2-Door Kit plus Rear Door Handles & Rear Door Pulls.

*Manual window kits do not include door pulls.

Description	Brushed Silver	Chrome
Interior Trim Accent Kit, 07-10 2-DOOR - Manual Trans - Manual Windows NEW	11151.92	11156.92
Interior Trim Accent Kit, 07-10 2-DOOR - Auto Trans - Manual Windows NEW	11151.93	11156.93
Interior Trim Accent Kit, 07-10 4-DOOR - Manual Trans - Manual Windows NEW	11151.97	11156.97
Interior Trim Accent Kit, 07-10 4-DOOR - Auto Trans - Manual Windows NEW	11151.98	11156.98
Interior Trim Accent Kit, 07-10 2-DOOR - Manual Trans - Auto Windows NEW	11151.90	11156.90
Interior Trim Accent Kit, 07-10 2-DOOR - Auto Trans - Auto Windows NEW	11151.91	11156.91
Interior Trim Accent Kit, 07-10 4-DOOR - Manual Trans -Auto Windows NEW	11151.95	11156.95
Interior Trim Accent Kit, 07-10 4-DOOR - Auto Trans - Auto Windows NEW	11151.96	11156.96



Trim can be painted to match your custom interior!

Components

- A. Shifter Trim Manual Transmission
- B. Shifter Trim Automatic Transmission
- C. AC Vent Cover [Pair] *Need 2 pairs
- D. Tweeter Speaker Grille [Pair]
- E. Steering Wheel Spoke Accents [Set]
- F. Front Cup Holder Trim
- G. Dash Panel Accent Trim [Pair]
- H. Grab Bar Handle
- I. Interior Door Handle Covers [Pair] *Need 2 pairs for 4-Door
- J. Front Door Pull Handle [Pair] *
- K. Rear Door Pull Handle [Pair]. [For 4-Door Only] *
- L. Rear Cup Holder Accent, 2Dr/4Dr, NEW

Brushed Silver

Chrome

Components	Brushed Silver	Chrome
A. Shifter Trim Manual Transmission	11151.01	11156.01
B. Shifter Trim Automatic Transmission	11151.02	11156.02
C. AC Vent Cover [Pair] *Need 2 pairs	11151.10	11156.10
D. Tweeter Speaker Grille [Pair]	11151.11	11156.11
E. Steering Wheel Spoke Accents [Set]	11151.12	11156.12
F. Front Cup Holder Trim	11151.13	11156.13
G. Dash Panel Accent Trim [Pair]	11151.14	11156.14
H. Grab Bar Handle	11151.15	11156.15
I. Interior Door Handle Covers [Pair] *Need 2 pairs for 4-Door	11151.20	11156.20
J. Front Door Pull Handle [Pair] *	11151.16	11156.16
K. Rear Door Pull Handle [Pair]. [For 4-Door Only] *	11151.17	11156.17
L. Rear Cup Holder Accent, 2Dr/4Dr, NEW	11151.18	11156.18

* For models equipped with power windows only. Will not work with manual windows.

All images are subject to be representative. More detailed information is available online.

Doors

HALF DOORS

NEW!



*Paintable impact resistant thermoplastic outer door skins!

Features and Benefits

- Get the open air fun and factory look for a lot less money. Finally the half door solution Jeep® owners have been waiting for!
- Impact resistant thermoplastic black ABS material with enhanced UV protection.
- Matte finish is easily paintable for custom match factory look.
- Specially reinforced internal steel frame provides strength and is powder coated to resist corrosion.
- The interior of our new half doors were not forgotten about in development. The textured inner ABS panels provide a finished look and feature a grab handle and molded storage pocket.
- Light weight half doors provide added convenience and utility with improved visibility on the trails.
- Each door has a weather tight seal to keep out moisture and reduce wind noise.
- OE Style Hinges provide a factory look and are designed to last.
- Durable and lockable paddle handle.
- Matching soft upper doors available for all season protection from the weather.
- Designed to work with your original mirror or for added convenience permanently install a pair of Rugged Ridge® replacement mirrors.
- Adjustable nylon door strap allows you to control and adjust how far the door opens.
- Attaches to factory hinge and door latch locations—easy no-drill install.
- Front pairs fit 2-door and 4-door Fronts, Rear pairs fit 4-door Rears.



Rugged Ridge® Half Doors

	Part #
Half Door, Front, Jeep® Wrangler (JK) 07-12 (Pair) NEW	11509.01
Half Door, Rear, Jeep® Wrangler (JK) 07-12 (Pair) NEW	11509.02
Upper Soft Door, Front, Jeep® Wrangler (JK) 07-12 (Pair) NEW	13711.15
Upper Soft Door, Rear, Jeep® Wrangler (JK) 07-12 (Pair) NEW	13712.15

TUBE DOORS

Like the “doors off” feel but also want the added convenience and utility of having doors on the trail? Rugged Ridge® Tube Doors are constructed from durable 1.5” mandrel bent steel tube that is E-Coated primered and then textured powder coated for a long lasting finish. Tube doors help increase visibility when climbing obstacles and trail riding. The Tube Doors interchange easily with the factory steel doors and require no body modification for installation. They are light weight and small enough to be stored easily in back of the vehicle when not in use.

Features and Benefits

- Thicker than most other tube doors with durable 1.5” diameter steel tubing construction providing added strength and great looks.
- E-coat and textured powder coat for corrosion resistance.
- Tube doors provide added convenience and utility for improved visibility on the trails.
- Design to work with your original mirror or for added convenience permanently install a pair of Rugged Ridge® replacement mirrors.
- Adjustable nylon door strap allows you to control and adjust how far the door opens.
- Half doors are easy to install and remove and are small enough to be stored in the vehicle.
- Optional cargo storage kit available that can be configured to use in a variety of ways.
- Durable and lockable paddle handle.
- Sold as a front pair and also a rear pair is available for 4 door JK.
- Attaches to factory hinge and door latch locations, easy no-drill install.



Rugged Ridge® Tube Doors

	Part #
Tube Doors Front, JK 07-12, pair NEW	11509.10
Tube Doors Rear, JK 4-Door 07-12, pair NEW	11509.11



TUBE DOOR CARGO COVERS

Add a fully adjustable Molle / Pals storage solution to your tube doors! The Rugged Ridge® Tube Door Cargo Covers are made from 600 denier polyester fabric with a durable vinyl backing. Our storage solution features an assortment of five different storage pouches with internal storage compartments. The great Molle / Pals mounting system allows you to arrange the pouches however you wish, or grab them and go! They mount on any backpack that features the Molle / Pals system! The tube doors and Cargo Covers take up less space than the OE steel doors, so unlike other systems you still have plenty of room for your knees! The Cargo Covers are designed with adjustable mounting straps that allow you to configure the cargo system with both Rugged Ridge® and most other aftermarket tube doors.

Rugged Ridge® Tube Doors Cargo Covers

	Part #
Tube Door Cargo Covers, JK 07-12 NEW	13247.01

NEW!

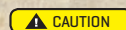

DOOR LATCH SET

Door latches are included with half doors and tube doors, but are available separately for custom applications.

Door Latch Set

	Part #
Half & Tube Doors, 07-12 Wrangler, Pair NEW	11812.80

NEW!



BILLET DOOR STOPS



COMING SOON

These billet mechanical door stops replace the troublesome nylon door check straps that are provided from the factory. The billet door stops incorporate a sliding arm with two stop positions that keep the door from swinging closed when passenger exists the vehicle. The dual nylon heim joints allow the door to open and close smoothly, while the billet stop keeps the doors from swing free and damaging the hood and fender. They also feature an easy quick release so you can remove the doors for off road use. Easy no drill installation!

Billet Door Stops	Part #
Wrangler 07-12, Each COMING SOON	11238.31
Wrangler 07-12, Pair COMING SOON	11238.30

QUICK RELEASE MIRROR RELOCATION



The mirrors mount to a bolt on bracket and are secured with a locking knob that allows for easy installation and removal. The long adjustable arms give you great visibility with your doors off or on! Available in durable black powder coat or stainless steel finish.



07-12 Wrangler Relocation Mirrors	Part #
Quick Release Mirror Relocation Kit, Pair, Black NEW	11025.10
Mirror Relocation Kit, Black, Includes Mirror, LH or RH Does Both Sides NEW	11025.11
Quick Release Mirror Relocation Kit, Pair, Stainless Steel, Does Both Sides NEW	11026.10
Mirror Relocation Kit, Stainless Steel, LH or RH Does One Side NEW	11026.11

FACTORY STYLE JK MIRRORS FOR WRANGLER

Factory Style Replacement Mirrors for JK	Black	Black w/LED	Chrome	Chrome w/Led
07-12 Wrangler, Passenger Side NEW	11002.12	11002.14	11010.12	11010.14
07-12 Wrangler, Driver Side NEW	11002.13	11002.15	11010.13	11010.15
07-12 Wrangler, Kit, Pair NEW	11002.21	11002.22	11010.11	11010.16



11002.13

* Fits 2011-2012 Wrangler models equipped with manual mirrors. Will not work with power mirrors.



11010.13



11002.14



11010.14



REAR VIEW MIRRORS



11020.02 Rear View Mirror, Black, 07-12 Jeep® Wrangler

Rear View	Part #
07-12 Wrangler, Each*	11020.02
Mounting Glue, Each	11021.01

* Includes mounting glue button.



11026.04, 07-12 Wrangler

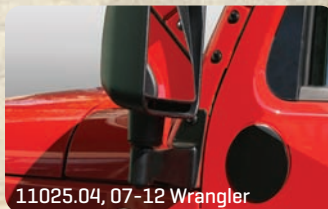

11025.04, 07-12 Wrangler

MIRROR RELOCATION BRACKETS & DOOR FILLER PLATES

Custom designed brackets bolt into existing holes on the windshield relocating your mirrors off the door. The perfect add-on accessory for those off-road adventures where you do not want your doors. Each bracket kit for the 2007-12 Wrangler comes with a special paintable filler plate to cover up the hole created when you remove your mirrors. Sold in pairs.

When you want to remove your doors from your Jeep® and permanently mount side mirrors to your "A" pillar, you need a filler plate to fill the left over hole on your door. Each steel filler plate attaches to the door using enclosed bolts and can be easily painted to match your door. These filler plates can also be used on Rugged Ridge® half doors and are a perfect addition when using the new Rugged Ridge® Quick release mirrors #11025.10 which place the mirrors directly on the A pillar.

Mirror Relocation Brackets	Stainless	Black
07-12 Wrangler w/Filler Plate, Pair	11026.04	11025.04
07-12 Wrangler, Pair NEW	11026.10	11025.10
07-12 Wrangler, Pair NEW	11026.11	11025.11

Fits 2011-2012 Wrangler models equipped with manual mirrors. Will not work with power mirrors.

Mirror Relocation Filler Plates	Part #
07-12 Wrangler, Black, Pair NEW	11025.05

All images are subject to be representative. More detailed information is available online.

NEOPRENE GRAB HANDLE AND DOOR HANDLE COVERS

Protect and upgrade the look of your Wrangler with these easy to install door and grab handle wraps. Each wrap is constructed of durable neoprene and covers each door handle as well as the passenger side grab handle. Four door models include 5 pieces [Grab Handle and four door handles] while two door models have 3 pieces [Grab Handle and two door handles].



Grab & Door Handle Kit	Black	Red
07-10 Wrangler 4-Door, 5 pc. Kit	13305.54	13305.55
07-10 Wrangler 2-Door, 3 pc. Kit	13305.56	13305.57

FIRE EXTINGUISHER HOLDERS

Special designed holder incorporates thick nylon web straps that secures your Fire extinguisher to the roll bar. Straps are fully adjustable and secure with hook and loop fasteners. Holds one 3lb. fire extinguisher [not included].

13305.21



Roll Bar Fire Extinguisher Holder	Black	Red
For all Jeep® 3" Roll Bars, Each	13305.21	13305.20

ROLL BAR DRINK HOLDER

Quickly places a convenient drink holder anywhere along your Jeeps® Sport Bars. Padded nylon drink holders attach with quick release "hook & loop" straps and hold a variety of cups and water bottle sizes. Foam insulation keeps your favorite beverage cool in the hot summer sun. Packed in pairs for both front and back seat use.



Roll Bar Drink Cup Holder	Part #
For all Jeep® Roll Bars, Pair	12101.51

LED COURTESY LIGHTS

The natural design of a Jeep® interior does not provide adequate interior lighting for map reading or looking for items inside your Jeep®. Now you have two outstanding options for interior lighting with the new Rugged Ridge® LED Courtesy Lights. Each lighting option features an extra bright, energy efficient LED light powered by 3 AAA batteries [not included] so there is no wiring required. The Roll Bar mount design attaches to any 2-3" roll bar using heavy duty straps and hook and loop fasteners. The NEW header mount courtesy light attaches with screws to the interior location of your choice. However, we suggest it being placed on the front header portion of the 2007-2012 Wrangler putting light in the center front of your Jeep® interior within easy reach of both driver and passenger. In this application, the screws mount directly to the plastic header making installation easy, secure and providing maximum lighting for the interior of your Jeep®.

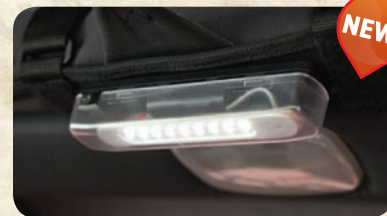

LED Courtesy Lights	Part #
Interior Courtesy Light, LED, Front Header Screw mount, Jeep® Wrangler [JK] 2007-2012 NEW	12430.01
Interior Courtesy Light, LED, Roll Bar Mounted, Universal Application [With 2-3 Inch Roll Bar] NEW	11250.08

TAILGATE STOP

This billet aluminum door stop incorporates a sliding arm that locks into place keeping your tailgate door open even on the most severe slopes. Load your Jeep® with ease! Some drilling required to install on the inside of your tailgate.



Tailgate Stop	Part #
07-12 Wrangler, Each	11238.11

ROLL BAR DOME LIGHT



Hard wired light illuminates the cab area of your Jeep®. Attaches to the roll bar with easy to use straps. No drilling required.

Roll Bar Dome Light	Part #
For all Jeeps® Roll Bars	11250.01

BACK SEAT HEATER

This 300 watt, 12 volt heater will warm your vehicle quickly keeping you and your passengers comfortable. Designed to fit on the rear wheel well of any Jeep®, this easy to use heater wires easily to your existing electrical system. Some drilling may be required.



Back Seat Heater	Part #
All Jeeps® & SUV's	13150.01

FLASHLIGHT HOLDERS

Keep your flashlight where you know it will always be. Choose either the sport bar holder or the steel mounting brackets, which screw mount to any flat surface. Flashlight not included, but you knew that.



11238.06



11205.20 Sportbar Flashlight Holder

Flashlight Holders	Part #
Sport Bar Flashlight Holder, 07-12 Wrangler, Each	11205.20
Mounting Brackets for 1.5" Diameter Flashlights, Universal Application, drilling required, Pair.	11238.06

ROLL BAR COAT HANGER KIT

Makes hanging your coat or laundry easy. Attaches to the roll bar with two nylon straps. Sold in pairs.

11250.03



Roll Bar Coat Hanger	Part #
For all Jeeps® w/Roll Bars	11250.03



ULTIMATE/DELUXE/NEOPRENE AND SPORT GRAB HANDLES

Put easy to use Grab Handles wherever you need them. Constructed of tough nylon webbing with either a molded sure-grip handle (Ultimate), soft foam handle (Deluxe) or plain Nylon webbing (Sport). The Ultimate Grab Handles are available in two hot colors to accent the Jeeps® interior-Red & Black. Deluxe and Sport models fit all Jeep® roll bars and 3" roll cages with padding. Ultimate Grab Handles will fit 2" or 3" padded or un-padded roll bars. All designs are packed in pairs.



13305.02 Deluxe Grab Handle



13505.03 Ultimate Grab Handle



13305.01 Sport Grab Handle

Ultimate/Deluxe and Sport Handles, 07-10 Wrangler

Ultimate Grab Handles, Pair - Red	13505.03
Ultimate Grab Handles, Pair - Black	13505.04
Deluxe Grab Handles, Pair	13305.02
Sport Grab Handles, Pair	13305.01
Neoprene Wrapped Deluxe Grab Handles, Passenger/Driver Side Roll Bar, Pair - Black	13305.30
Neoprene Wrapped Deluxe Grab Handles, Passenger/Driver Side Roll Bar, Pair - Red	13305.31

Part #

13505.03
13505.04
13305.02
13305.01
13305.30
13305.31



13505.04 Ultimate Grab Handle



13305.30 Neoprene Wrapped Deluxe Grab Handle

Wrangler 07-12

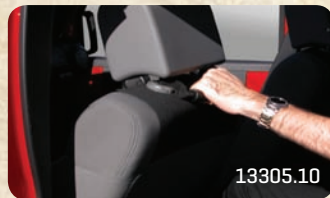

13305.10



13305.15

Dual Application



13305.14



13305.15

GRAB HANDLES FOR 2007-12 JEEP® WRANGLER

Three styles to choose from - Rear Side Grab Handles for easy entry and exit attach directly into factory mounting holes with your original hardware. They also double as Front Seat Grab Handles by easily attaching to the windshield pillar with supplied hardware. Rear Seat Grab Handles attach to the head rest of your JK front seats. Finally, we have developed a Neoprene Wrapped design for over driver and passenger that completes the entire JK package!

Grab Handles

	Red	Black
07-12 Wrangler, Seat Mount Grab Handles, Pair	13305.11	13305.10
07-12 Wrangler Rear Side/Windshield Pillar Grab Handles, Pair	13305.15	13305.14
07-12 Wrangler, Black, 5 Piece Kit NEW*		12496.14

*Includes: 13305.04, 13305.14 & 13305.12



13305.13 Center Roll Bar Dual Grab Handle

REAR DUAL GRAB STRAP FOR JEEP®

Gives back seat passengers a place to hold on while on the trail. Constructed of durable nylon webbing with soft molded foam handles for ease of use and comfort. Easily attaches with hook and loop around the center roll bar or to factory mounts. No drilling required. Special side "pockets" create a handy spot for hanging clothes.

Rear Dual Grab Strap

	Red	Black
07-12 Wrangler, Each	13305.13	13305.12



11119.05 Entry Guards, 4-Door 07-12 Wrangler, Stainless



11216.10

BLACK & STAINLESS ENTRY GUARDS

Protect your door threshold with these stylish entry guards. Available in three different finishes, black, polished stainless and aluminum to enhance the look of your Jeep® while providing the ultimate in protection. 2007-12 Wrangler entry guards available for 2 & 4-Door models [2-Door kits will fit front 4-Door applications]. 2007-12 Wrangler models attach without screws using durable double sided automotive grade adhesive.

Entry Guards

	Stainless	Black
07-12 Wrangler Front Door Openings Only [2 & 4-Door] Pair	11119.04	11216.10
07-12 Wrangler 4-Door Rear, Pair	11119.05	11216.11

All images are subject to be representative. More detailed information is available online.

BUG DEFLECTOR SHIELD

Protect your windshield and hood from flying debris and bugs with this durable Bug Deflector from Rugged Ridge®. Constructed of durable shatter resistant smoked acrylic, this bug shield is designed to last the test of time. Installation is easy using double sided automotive adhesive tape and under hood screw attachments (some drilling required).



NEW!

Rugged Ridge® Bug Deflector Shield	Part #
07-12 Wrangler NEW	11350.02

WINDOW RAIN DEFLECTOR

NEW!

Rugged Ridge® Window Rain Deflector	Part #
Front, Smoked Acrylic, Wrangler 2-Door [JK] 07-12 NEW	11351.11
Front & Rear, Smoked Acrylic, Wrangler 4-Door [JK] 07-12 NEW	11351.12



GRILLE/BILLET GRILLE INSERTS

Durable UV treated inserts enhance the front of your Jeep®. Available in your choice of Black or Chrome with or without aluminum billet inserts, these inserts add great styling and a unique appearance. All Rugged Ridge® inserts easily install without drilling or tools. Just click them in and go! Add on the black or stainless Euro-Guards or black headlight bezels for the sharpest look on the market!



11306.30 Black Grille Inserts



11401.30 Black w/Aluminum Billet Grille Inserts



COMING SOON

11401.31 Billet Grille Insert Screen

Grille Inserts	Black
Black, 2007-12 Wrangler , Set of 7	11306.30
Black w/ Aluminum Billet, 2007-12 Wrangler , Set of 7	11401.30
Billet Grille Insert Screen, Gloss Black, 2007-2011 Wrangler NEW	11401.31



PARKING LIGHT BEZELS



Parking Light Bezels	Part #
Black, 07-12 Wrangler, Pair NEW	12419.26

REPLACEMENT HEADLIGHT BEZELS

Complete the look of your front end with these easy to install head light and turn signal lamp bezels from Rugged Ridge®. Each UV treated bezel easily attaches to factory mounting points creating a clean look. Matched up with the Rugged Ridge® Grille Inserts, you now have that HOT look.



NEW!

12419.25

Headlight Bezels	Black
07-12 Wrangler, Pair NEW	12419.25

HOOD SCOOPS

Increase the efficiency of your heater and air conditioner with these easy to install Hood Scoops. Available in UV treated chrome plastic, black UV treated plastic or durable smoked acrylic for long life and matching good looks. Ram Induction hood scoop is designed to provide maximum air flow to your passenger compartment. Installation is easy with double sided automotive grade tape. No drilling required. Mounts facing either direction.



Hood Scoops	Smoked	Black
07-12 Wrangler	11352.10	11352.12



The Complete Look for your JK:
11230.03, 11231.11, 11231.12,
11231.13

FRONT EURO-GUARDS

Protect your headlights from debris and get that off road look with a set of Rugged Ridge® Euro-Guards. Constructed of durable powder coated steel, these front Euro-Guards are designed to last. No drilling required for installation. Each kit comes with a pair of guards to cover both sides of the vehicle. The side marker light guards are a great compliment to our front light Euro-Guards. Installation is easy and light visibility is not hampered. The parking light guards are designed to match our Headlight Euro-Guards. They feature the same great style and construction. They give a rugged look while protecting the lense. Sold in pairs.

Black Front Euro Light Guards		Part #
07-12 Wrangler *, Pair	Head Light Guards	11230.03
07-12 Wrangler *, Pair	Parking Light Guards	11231.11
07-12 Wrangler *, Pair	Side Marker Light Guards	11231.12
07-12 Wrangler, 4 Pc Kit	Parking Light & Side Marker Guards NEW	11231.02

* fits 2 and 4-Door Wrangler



11231.02 Kit

FOG LAMP EUROGUARDS FOR 07-12 WRANGLER

Protect those expensive fog lights from impact with the Rugged Ridge® Euro Light Guards. Each Euro Light Guard is easy to install with no adhesive or drilling required. They are available in a textured black powder coat finish for long life and to match the other Rugged Ridge® Euroguards.



EURO GUARD FOG LIGHT COVERS	Part #
07-12 Wrangler	11231.13*

* Except Sahara models

Create a custom look in just a few minutes. This special design fits directly over the existing gas cap opening. Available in locking and non-locking versions. They are specially treated to resist blemishes caused by gasoline or other hazardous chemicals. 2007-12 models attach with self tapping screws to plastic inner liner.

BILLET STYLE GAS COVERS



11229.02

11425.06

Application	Finish	Part #
07-12 Wrangler	Black Aluminum, Each	11425.05
07-12 Wrangler	Black Aluminum, Locking, Each	11425.06
07-12 Wrangler	Black Painted Stainless, Each	11229.02
07-12 Wrangler	Black Painted Stainless, Locking, Each	11229.03

REAR EURO-GUARDS

Protect and upgrade the look of your Jeep® with a set of Rugged Ridge® Euro Taillight Guards. Each Rear Euro Taillight Guard is easy to install with no drilling required. Rubber inserts around the mounting screws on 2007-12 models keep the metal Euro Guard off the taillight, preventing scratching and rattles.



11226.02 Rear Euro Guard, 07-12 Wrangler

Rear Euro Guards	Part #
07-12 Wrangler, Pair	11226.02

HINGE TREATMENTS FOR 2007-12 WRANGLER

These cast steel design Hinge Treatments are guaranteed not to rust while providing a new beefy look. Door and Hood Hinge covers feature an easy-to-install design. Replacing your existing hinges can break & crack the surrounding paint, as the hinges were painted at the factory after installation. These covers retain the stock hinges but give it a new look without harming your expensive paint. A direct bolt on - no drilling required, fits either side. Use 4 hinge treatment pairs for 4-Door models, 2 pairs for 2-Door models and 1 pair for hood.



Hinge Treatment, Black	Part #
07-12 Wrangler, Pair	11205.10*
07-12 Wrangler 2-Door, Set of 4	11202.04
07-12 Wrangler 4-Door, Set of 8	11202.05

Hood Set, Black	Part #
07-12 Wrangler, Set	11201.04

11201.04 Hood Set, 07-12 Wrangler



HOOD SETS

Make your Jeep® Wrangler unique with genuine Rugged Ridge® black exterior accessories. All accessories are powder coated in a semi gloss finish to protect your investment against the elements. Every part or kit comes with complete hardware to ensure a trouble free installation. No matter if you choose our "Locking Hood Catch", "Gas Hatch Cover" or the complete "Hood Set", Rugged Ridge® Accessories truly change and upgrade your Jeep® dramatically.

WINDSHIELD TIE DOWN KITS

These windshield tie down kits are made of steel, not plastic, for durability.



Windshield Tie Down Kits	Part #
07-12 Wrangler [1 footman loop, 2 hood bumper accents, & 1 washer nozzle cover], 4-Pc. Kit	11201.05

Wrangler 07-12

WINDSHIELD HINGES/BRACKETS



11209.03
Windshield
Bracket, 07-12
Wrangler

Windshield Hinge Bracket	Part #
07-12 Wrangler, Windshield Hinge Brackets, Pair	11209.03

WINDSHIELD LIGHT BRACKETS

Easily and quickly mounts to your factory windshield hinge creating two great spots for off-road lighting. Foam backing protects your vehicle's finish. No drilling required for installation. Sold in pairs with all mounting hardware.



11027.03 Windshield
Brackets, 07-12 Wrangler

Stainless Windshield Light Brackets (Pair)	Part #
07-12 Wrangler	11027.03

HOOD VENT COVERS



11206.05 Hood Vent Cover,
07-12 Wrangler

Hood Vent Cover	Part #
07-12 Wrangler, Each	11206.05

CAST BLACK STEEL DOOR HINGES

You have black bumpers, a black top, black mirrors, black door handles and black euro-guards, why not complete the look with a set of black cast steel replacement door hinges from Rugged Ridge®? These aren't the stick on covers that our competitors offer. The heavy duty cast construction and powder coated finish ensure these hinges are built to last. The hinges are offered in sets for both the doors and hood. Includes matching black allen head bolts to complete the installation. They are direct bolt on replacement hinges for an out of the box solution, but without out all the fuss and mess of painting your factory hinges.

11202.23



NEW!



11202.22

Door Hinges	Part #
Cast Steel Hinges, RH, Pair NEW	11202.22
Cast Steel Hinges, LH, Pair NEW	11202.23

MIRROR RELOCATION BRACKETS

Custom designed brackets bolt into existing holes on the windshield, relocating your mirrors off the door. The perfect add-on accessory for those off-road adventures where you do not want your doors. The 2007-12 Wrangler bracket kit comes with a Black filler plate to cover up the holes created when you remove your mirrors.



Black Mirror Relocation Brackets (Pair)	Part #
07-12 Wrangler w/Filler Plate	11025.04

*Fits 2011-2012 Wrangler models equipped with manual mirrors. Will not work with power mirrors.

FULL FRAME LIGHT BAR

This three-piece light bar simplifies your installation dramatically because you won't run the risk of scratching up your windshield frame trying to mount a heavy one-piece bar with five lights onto your windshield hinges. With this bar you can install one piece at a time. The bar is powder coated in black and packaged in a easy to ship box for your convenience.



Full Fame Light Bar	Black
07-12 Wrangler, 3 Pcs.	11232.21



See page J49 for NEW Rugged Ridge® Off-road lighting

RUGGED RIDGE® BODY ARMOR FOR 2007-12 WRANGLER

Get that offroad look with Rugged Ridge® Body Armor! Each Body Armor piece is constructed of black diamond plate UV treated thermoplastic for the coolest, toughest looking upgrade for your Jeep®. Each body Armor attaches to your Jeep® with ultra strong 3M tape to ensure a secure fit. Have a scratch or dent on your paint? Cover it up with Body Armor! Simply fill in the scratched area with touch-up paint [to prevent rust] and install the Body Armor. You have now repaired and upgraded! Available in individual pieces or complete styling "kits", so you can customize the look of your Jeep® the way you want.

COWL BODY ARMOR

Protect your cowl from mirror damage with Cowl Body Armor from Rugged Ridge®. Whenever your door limiter straps are disconnected the door can over extend causing damage to your cowl area. These new cowl covers protect your cowl area while providing a great look. Constructed of durable UV thermoplastic, these covers easily attach using 3M double sided automotive grade adhesive. Packed in pairs.

Cowl Body Armor

Part #

07-12 Wrangler Matte Black, Pair **NEW** 11651.18



11651.17 Hood Stone Guard



11651.01 Rear Corner Guards

11651.18 Cowl Body Armor

11651.05 Rocker Side Panel

Body Armor Components

Rear Tall Corner, Pair *

Rocker Side Panel, Kit *

Hood Stone Guard, Each *

* May require modification to fit with Bushwacker brand rear fender flares.

**07-12 Wrangler
2-Door**

**07-12 Wrangler
4-Door**

11651.02

11651.01

11651.06

11651.05

11651.17

11651.17

Body Armor Kits for 07-12 Jeep® Wrangler

Part #

07-12 Wrangler 2-Door, Kit † Rear Tall Corners, Pair [11651.02]
Rocker Side Panel, Pair [11651.06]
Hood Stone Guard [11651.17]

11651.51

07-12 Wrangler 4-Door, Kit † Rear Tall Corners, Pair [11651.01]
Rocker Side Panel, Pair [11651.05]
Hood Stone Guard [11651.17]

11651.50



REAR CORNER GUARDS BODY ARMOR



11651.02 Rear Corner Guards



11651.02 Rear Corner Guards

ROCKER SIDE PANEL BODY ARMOR



11651.05 Rocker Side Panel

HOOD STONE GUARD BODY ARMOR



11651.17 Hood Stone Guard

All images are subject to be representative. More detailed information is available online.

Exterior Stainless Accessories

Get the ultimate WOW factor with Rugged Ridge® polished stainless steel accessories! These beautiful bolt on accessories turn even the most worn Jeep® into a hot street machine. Constructed of prime 304 stainless steel that has been polished to a mirror finish, these accessories are built to last. 304 stainless steel is virtually rust proof guaranteeing that these parts will stand the test of time. All hardware is also constructed of stainless steel so the polished look you are going for is complete. Rugged Ridge® offers the most complete line of stainless accessories so you can truly customize the look of your vehicle. When you want the best, look to Rugged Ridge® Stainless Accessories!

Wrangler 07-12

WINDSHIELD TIE DOWN KITS



11101.05

Windshield Tie Down Kit	Part #
07-12 Wrangler, Stainless Kit (Footman loop, windshield bumper covers, washer cover)	11101.05

HOOD CATCHES

Available in polished 304 Stainless Steel or Chrome, these catches will keep your Jeep's® hood in place regardless of how rough the ride gets!



11116.06 Hood Catch, 07-12 Wrangler

Hood Catch, Stainless	Part #
07-12 Wrangler, Pair (Cast Stainless)	11116.06

STAINLESS STEEL HOOD KITS



11101.04

Hood Kit, Stainless	Part #
07-12 Wrangler, 7 pc. Kit	11101.04
Hood Vent, Stainless	Part #
07-12 Wrangler	11117.05

STAINLESS HINGE TREATMENTS FOR 2007-12 WRANGLER

These cast stainless design Hinge Treatments are guaranteed not to rust while providing a new beefy look. Door and Hood Hinge covers feature a easy-to-install design. Replacing your existing hinges can break & crack the surrounding paint, as the hinges were painted at the factory after installation. These covers retain the stock hinge but give it a new look without harming your expensive paint. A direct bolt on - no drilling required, fits either side. Use #11113.06 for 4-door models, #11113.05 for 2-door models and #11111.10 for hood.

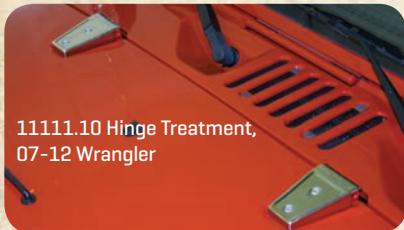

11111.10 Hinge Treatment, 07-12 Wrangler



11111.10 Hinge Treatment Can Be Used on Door or Hood

Hinge Treatment	Stainless
07-12 Wrangler, Pair	11111.10
07-12 Wrangler 2-Door Kit, 4 Hinges	11113.05
07-12 Wrangler 4-Door Kit, 8 Hinges	11113.06

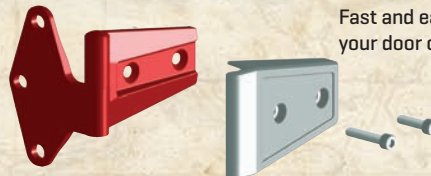

Fast and easy installation on your door or hood hinges



STAINLESS HINGES FOR 2007-12 WRANGLER

Solid stainless steel can't be beat for longevity and that's why Rugged Ridge® now offers stainless steel hinges for the 07-12 Wrangler. These hinges are a direct bolt-on replacement for the stock units. Installation is easy with only simple hand tools. Both door and hood hinge sets are available for a complete vehicle makeover. Includes matching stainless steel hardware.



11111.22

Stainless Steel Hinges for 07-12 Wrangler	Part #
Door Hinge Kit, 07-12 Wrangler 2-Door, 4 Hinges	11111.20
Door Hinge Kit, 07-12 Wrangler 4-Door, 8 Hinges	11111.21
Hood Hinge Kit, 07-12 Wrangler, Pair	11111.22



11111.21

STAINLESS & BILLET STYLE GAS HATCH COVERS

Create a custom look in just a few minutes. This special design fits directly over the existing gas cap opening. These tough gas covers are available in either stamped stainless steel, polished aluminum or chromed aluminum and are specially treated for resistance to gasoline and other chemicals. Unlike other designs on the market, installation does not require the removal of the tail light or internal gas cover components. For 2007-12 Wranglers the cover attaches directly to the original equipment plastic insert using self tapping screws with no need to remove the existing plastic insert. Available with or without locking mechanism. Please note that your factory gas cap is still required.

Application	Finish	Part #
07-12 Wrangler, Each	Stainless Steel	11134.02
07-12 Wrangler, Each	Stainless Steel, Locking	11134.03
07-12 Wrangler, Each	Chromed Aluminum	11425.03
07-12 Wrangler, Each	Chromed Aluminum, Locking	11425.04



11134.03

STAINLESS STEEL WINDSHIELD HINGES/BRACKETS

These hinges and brackets are one of those pieces that really shows off an attention to detail. They install quickly and easily and add a little bit of flash. Sold as a matching left/right hand pair. Includes all necessary hardware.



11112.03

Stainless Windshield Hinges	Part #
07-12 Wrangler, Pair - Bracket	11112.03

MIRROR & MIRROR ARM COVERS

Give your JK Wrangler a unique look with these mirror and arm covers. Available in pairs as mirror covers, just the arms or a kit for both. Made from chrome plated ABS plastic, these pieces are an easy install, using pre-applied double-sided tape.



13311.02 Mirror Arm Cover



13311.01 Mirror Cover



13311.03 Mirror Cover Kit

Mirror & Mirror Arm Covers	Part #
Mirror Covers, Chrome, 07-12 Wrangler, Pair	13311.01
Mirror Arm Covers, Chrome, 07-12 Wrangler, Pair	13311.02
Mirror Cover Kit, Chrome, 07-12 Wrangler, 4 Piece Kit	13311.03

WINDSHIELD LIGHT BRACKETS

Easily and quickly mounts to your factory windshield hinge creating two great spots for off-road lighting. Foam backing protects your vehicle's finish. No drilling required for installation. Sold in pairs with all mounting hardware.



Stainless Windshield Light Brackets (Pair)

07-12 Wrangler

11028.03



11028.03

Part #

11028.03

MIRROR RELOCATION BRACKETS

Custom designed brackets bolt into existing holes on the windshield, relocating your mirrors off the door. The perfect add-on accessory for those off-road adventures where you do not want your doors. The 07-12 Wrangler bracket kit comes with a Stainless filler plate to cover up the holes created when you remove your mirrors. *Fits 11-12 Wrangler models equipped with manual mirrors. Will not work with power mirrors.

Stainless Mirror Relocation Brackets (Pair)

07-12 Wrangler w/Filler Plate

Part #

11026.04

ANTENNA BASE COVER

This chromed plastic antenna base cover is a quick and easy way to add a touch of flash to your 07-12 Wrangler. Simply unscrew your factory antenna and place the cover over the factory antenna base. Installation is easy thanks to the pre-attached durable double sided automotive grade tape.



Antenna Base Cover

07-12 Wrangler, Each

Part #

13311.26

DOOR HANDLE COVERS/RECESS GUARDS

Compliments Your Exterior Stainless Accessories

Give your Jeep® a great new custom chrome look in just a few minutes! Made from triple chrome plated ABS plastic, these exterior trim pieces are designed to resist flaking and oxidation. Easy no drill installation! They install in seconds using pre-applied double-sided tape. Buy the Recess Guard and door handle kits for the ultimate look!



Chrome Door Handle & Recess Guard



Black Recess Guard, Factory Door Handle



Chrome Door Handle Cover



Chrome Recess Guard, Factory Door Handle



Chrome Door Handle Cover

Door Handle Covers/ Recess Guards

Door Handle Covers/ Recess Guards	Part #
Chrome Door Handle Covers, 2-Door, 07-12 Wrangler, 3 Pc. Kit	13311.11
Chrome Door Handle Covers, 4-Door, 07-12 Wrangler, 5 Pc. Kit	13311.12
Chroms Door Handle Cover Replacement Piece, 07-12 Wrangler	13311.10
Chrome Door Handle Recess Guards, 2-Door, 07-12 Wrangler, 3 Pc. Kit	13311.15
Chrome Door Handle Recess Guards, 4-Door, 07-12 Wrangler, 5 Pc. Kit	13311.16
Chrome Door Handle Covers & Recess Guard Kit, 2-Door, 07-12 Wrangler, 6 Pc. Kit	13311.17
Chrome Door Handle Covers & Recess Guard Kit, 4-Door, 07-12 Wrangler, 10 Pc. Kit	13311.18
Black Door Handle Recess Guards, 2-Door, 07-12 Wrangler, 3 Pc. Kit	11651.25
Black Door Handle Recess Guards, 4-Door, 07-12 Wrangler, 5 Pc. Kit	11651.26

FRONT EURO-GUARDS

Protect those expensive headlights, turn signals and parking lights from impact with the Rugged Ridge® Euro Light Guards. Each Euro Light Guard is easy to install with no drilling required. They are of polished stainless steel for a true attention to detail.



Front Euro-Guards

Front Euro-Guards	Part #
07-12 Wrangler, Headlight Guards, Pair	11142.04
07-12 Wrangler, Parking Light Guards, Pair	11142.11
07-12 Wrangler, Side Marker Light Guards, Pair	11142.12
07-12 Wrangler, Fog Light Guards, Pair	11142.13



REAR EURO-GUARDS

Protect and upgrade the look of your Jeep® with a set of Rugged Ridge® Euro Taillight Guards. Each Rear Euro Taillight Guard is easy to install with no drilling required. Rubber inserts around the mounting screws on 2007-12 models keep the metal Euro Guard off the taillight, preventing scratching and rattles.

Rear Euro Guards

07-12 Wrangler, Pair

Part #

11103.03

GRILLE/BILLET GRILLE INSERTS

Durable UV treated inserts enhance the front of your Jeep®. Available in your choice of Black or Chrome with or without aluminum billet inserts, these inserts add great styling and a unique appearance. All Rugged Ridge® inserts easily install without drilling or tools. Just click them in and go! Add on the NEW black or stainless Euro-Guards or black headlight bezels for the sharpest look on the market!



11306.20 Chrome Grille Inserts



11401.20 Chrome w/Aluminum Billet Grille Inserts



Grille Inserts & Billet Inserts

2007-12 Wrangler, Set of 7

Grille Inserts

11306.20

Billet Inserts

11401.20

HOOD SCOOPS

Constructed of durable ABS plastic in 3 different finishes, these great looking Hood Scoops give your Jeep® an aggressive look! Each Hood Scoop has been designed to complement the lines of the Jeep® while enhancing airflow. Choose from three finishes; Smoke, polished chrome or textured black. Each attaches with tough automotive grade tape to ensuring a long life. Each scoop can be used with the opening facing the window or facing the front of the Jeep®, depending on your preference.

Air Scoop

Part #

07-12 Wrangler, Chrome, Each	11352.11
07-12 Wrangler, Smoked, Each	11352.10
07-12 Wrangler, Black, Each	11352.12



COMPLETE THE LOOK!

Complete the look of your new Wrangler with these chrome accessories from Rugged Ridge®. These UV-treated chromed plastic accents attach to your vehicle with durable double sided tape; the same tape used in attaching complete body kits to vehicles!

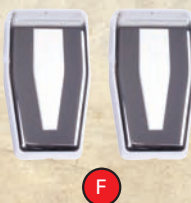

Exterior Accessories for 2007-12 Wrangler, 2 and 4-Door

Part #

A	Parking Light Trim, Chrome, 07-12 Wrangler, Pair	13311.22
B	Headlight Trim, Chrome, 07-12 Wrangler, Pair	13311.20
C	Fuel Filler Accent Trim, Chrome, 07-12 Wrangler	13311.23
D	Tail Light Covers, Chrome, 07-12 Wrangler	13311.21
E	Tailgate Hinge Covers, Chrome, 07-12 Wrangler	13311.24
F	Lift Gate Hinge Covers, Chrome, 07-12 Wrangler, w/Hardtop	13311.25

Custom designed to protect the steering components on all 2007-12 Jeep® Wranglers, this overbuilt skid plate is a must for those off road adventures. Constructed of durable 1/4" powdercoated steel with a rust resistant E-Coating, this Skid Plate is designed to take whatever the trail throws at you! Designed to fit with all Rugged Ridge® front bumpers (looks amazing with the XHD Bumper system!) or all factory front bumpers, this skid plate provides protection for all front steering components including the very expensive electric sway bar disconnect system found on Rubicon models. Easy to install frame mount design incorporates special gussets and welded brackets to ensure long life and great off road performance.

FRONT SKID PLATE FOR 07-12 WRANGLER



Front Skid Plate for 07-12 Wrangler	Part #
Front Skid Plate- All RR bumpers, all factory original bumpers NEW	18003.30

EVAPORATOR SKID PLATE

The Evaporator Skid Plate is constructed of durable 3/16" thick black powder coated steel, and mounts to existing body holes using the factory hardware. It helps transfer the load of an impact away from the evaporator tank and to the frame and cross member. Rugged Ridge® offers a wide variety of skid plates and body protection for Wranglers. You can wheel with confidence knowing these skid plates will help keep you from getting hung up on rocks, trail obstacles, while preventing damage to critical components.



Evaporator Skid Plate	Part #
07-11 Wrangler NEW	18003.40
2012 Wrangler COMING SOON	18003.41

MUFFLER SKID PLATE

The Muffler Skid Plate is constructed of durable 5mm thick black powder coated steel, and mounts to existing body holes using the factory hardware. It helps transfer the load of an impact away from the muffler and to the frame.



Muffler Skid Plate	Part #
07-12 Wrangler NEW	18003.31
* For OE exhaust only.	

HEAVY-DUTY DIFFERENTIAL COVERS

Indestructible! You won't break these covers, we guarantee it. Made of 3/8" cast steel, painted black inside and out, these heavy-duty covers are designed to protect your differential and all its working parts for as long as you own your vehicle. These indestructible covers have been "44 caliber tested" - if they can take a bullet at point blank range (don't try this at home!), they can take all that the trail has to offer. Available for most popular Dana differential types and include extra reinforcement protection for the fill plug area. All mounting hardware and instructions are included for easy of installation.

Differential Cover	Part #
Dana 30, Each	16595.30
Dana 35, Each	16595.35
Dana 44, Each	16595.44
Dana 60, Each	16595.60



TRANSFER CASE SKID PLATE



Transfer Case Skid Plate	Part #
07-12 Wrangler, Black NEW	18003.32

HEAVY-DUTY DIFFERENTIAL SKID PLATES

Protect your factory differential cover with these heavy-duty skid plates. Designed to fit the contours of your stock differential cover. Constructed of durable 3/16" black powder coated steel, these skid plates will help you slide over obstacles and not get hung up. Includes replacement mounting hardware and instructions. Now available with the Jeep® logo stamped into the face as an Authentic Jeep® Licensed product.



Heavy-Duty Differential Skid Plates	Part #
Dana 30 Diff. Skid Plate	16597.30
Dana 30 Diff. Skid Plate with Jeep® Logo	DMC-16597.30
Dana 35 Diff. Skid Plate	16597.35
Dana 35 Diff. Skid Plate with Jeep® Logo	DMC-16597.35
Dana 44 Diff. Skid Plate	16597.44
Dana 44 Diff. Skid Plate with Jeep® Logo	DMC-16597.44

CONTROL ARM SKID PLATES



Protect your control arms with these easy to install skid plates. Constructed of durable 3/16" black powder coated steel, these skid plates will help prevent getting hung up on rocks and other trail obstacles. Simply unbolt your control arm at the axle and slide this skid plate in place. Sold as a pair. Available for front and rear axles.

Sold as a pair. Available for front and rear axles.



Control Arm Skid Plates	Part #
07-12 Wrangler, Front, Pair	18003.35
07-12 Wrangler, Rear, Pair	18003.36
07-12 Wrangler, Front & Rear, Kit	18003.37

COMING SOON HEAVY DUTY ACCESSORIES

Coming Soon	Part #
07-12 Wrangler, Engine & Transmission Skid Plate, Blk Powder Coat NEW	18003.50
07-12 Wrangler, Frame Brace Kit NEW	18205.25
07-12 Wrangler, Inverted Drag Link NEW	18205.26



OFF ROAD JACK ROLL BAR MOUNTING BRACKET

Get your Hi Lift style jack out of the elements with this roll bar mounting kit from Rugged Ridge®. Storing your jack outside leaves it vulnerable to water, debris, ice and theft. These great new brackets allow you to secure your jack to the sports bar without sacrificing cargo area storage, and increase the longevity and function of your jack! The simple no drill installation allows for easy removal and storage of the jack.



Off Road Jack Roll Bar Mounting Bracket Part #

07-12 Wrangler **NEW** 11586.02

HEAVY DUTY TIRE SPACER

The Spare Tire Spacer bolts to your existing factory spare tire mount and relocates the tire two inches up and out. Both the HD Tire Carrier and Spare Tire Spacer feature 5x4.5" and 5x5.5" wheel bolt patterns and tough powder coated black textured finish. Caution: The tailgates on 07-12 Wrangler models are not designed to hold extra large tires. Therefore, do not use a tire larger than a 33x12.50" or equivalent tire with this spacer. If you want to carry a larger tire, we recommend using the XHD Rear Bumper with Tire Carrier.



Heavy-Duty Tire Carrier & Spacer

Part #

07-12 Wrangler, Textured Black, Each

11585.02

CAUTION: The tire carrier spacer is designed to fit tires 33" in diameter or less. Do not exceed these tire sizes

HOOD LOCK

Special design virtually disappears into the grille. Cam lock design keeps people out of the engine compartment of your Jeep®. These clever applications install in minutes. An upgraded internal lock cover keeps ice and debris from fouling the lock mechanism.

Hood Lock Kits

Part #

07-12 Wrangler, Each

11252.05



THIRD BRAKE LIGHT EXTENSION JK

The third brake light extension kit from Rugged Ridge is brake light solution JK owners have been waiting for. Our brake light extension kit is fully adjustable in 1" increments and works with the OE spare tire carrier and most aftermarket units as well! It is made from durable black powder coated steel. It moves the third brake light up above oversized spare tires from 33" to 42". Off road antenna mount or send flag mount integrated into design.

Third Brake Light Extension

Part #

Third Brake Light Extension, 07-12 Wrangler **NEW**

11546.23

OFF ROAD JACK MOUNT



JK Off-Road Jack Mount allows you to carry your Off-Road jack on the outside of your vehicle saving precious cargo space. Fast and easy bolt on installation. Compatible with stock and most aftermarket rear bumpers [without tire carriers] as well as Rugged Ridge® XHD rear bumper with or without tire carrier. Bracket is sturdy and secures the jack in two locations to eliminate any vibration noise during vehicle operation. Durable textured finish looks great. Fits most off-road style jacks including Hi-Lift™.

Off Road Jack Mount

Part #

Off Road Jack Mounting Bracket, Hi-Lift Style, Jeep® Wrangler [JK] 07-12

11586.01

Each Jack mount incorporates a special round cutout for padlock use.



Fits All Original Equipment And Rugged Ridge® XHD Rear Bumpers

Quick Release Knob Allows For Easy Jack Attachment/Removal

STAINLESS HEADERS FOR 2007-11 WRANGLER

Our custom Exhaust Headers are engineered to deliver improved performance. The 3.8L isn't a bad motor it just needs more air to "breathe" properly. Our headers increase exhaust gas exit velocity to move more air through the cylinder head's combustion chamber resulting in performance gains. They are constructed of 409 stainless steel to ensure a long operating life. Each complete kit includes manifolds, gaskets, hardware, clamps and easy to read instruction sheets.

NEW!



Stainless Steel Headers

Part #

07-11 Wrangler w/3.8L Engine, Each **NEW**

17650.53

STAINLESS STEEL CAT-BACK EXHAUST SYSTEM



Open up your Jeep®'s exhaust with this great looking & long lasting polished stainless steel dual exhaust system. You'll get a mellow exhaust note that will set your rig apart while enjoying increased performance. The 2 1/4" mandrel bent pipes give

hot exhaust gases a smooth exit without the constrictions found in crush-bent pipes. This added flow decreases back pressure and will actually increase the horsepower of your 3.8L or 3.6L engine! This is a bolt-on system that installs after the catalytic converter to keep your emissions legal. The dual split exits feature slash cut and rounded oval tips for a tough look. Each kit includes all necessary mounting hardware for an easy bolt on installation.

Stainless Steel Cat-Back Exhaust System

Part #

07-12 Wrangler 2-Door & 4-Door, Kit **NEW**

17606.75



MODULAR XHD SNORKEL

Dusty Trails Rides and Deep Water Fordings. –Anyone who takes their rig off-road is likely to encounter these conditions. The new Modular XHD Snorkel System from Rugged Ridge® relocates the venerable stock air intake location to help reduce dust clogged filters and the risk of hydro-locking your engine. It is also the first snorkel designed with the modular functionality of a Pre-filter Low Mount and Ram High Mount air intake design. Unlike other snorkels, you don't have to give up flexibility for functionality. Not only did we engineer our snorkel to allow the windshield to fold and doors to be removed, we built it for use with our dual battery tray, windshield light bar and windshield light mounting tabs... Because what good is having a snorkel to cross the river, if you have to leave your lights and the dual battery (to power your winch) on the other side?

The Modular XHD Snorkel System comes standard with the Pre-filter Low Mount. The Pre-filter Low Mount relocates the air intake to just below the windshield and draws cool air from outside the hot engine compartment. The optional Ram High Mount design allows the air intake to be extended up an additional 21" to the top of the windshield. The two air intake mounts are easily interchangeable to give you the modular functionality best suited to your needs. The system is manufactured from premium thermoformed plastic, mandrel bent aluminum and hi-temp silicone connection hoses. Built in manual drain valves channel away excess water to prevent it from entering the intake system. It installs with minor modification to the fender, but without the major cutting and surgery that other kits require. The new lower air cleaner box installs in place of the factory unit, so you don't have to "hack and tap". Just attached the factory upper air box, chose from the Pre-filter Low Mount or Ram High Mount design and go!

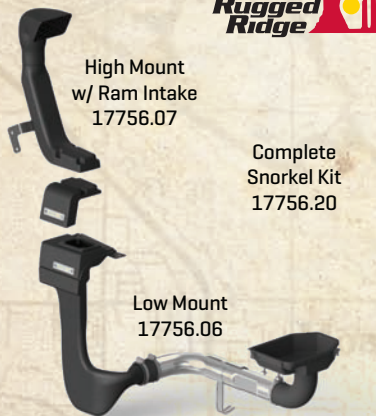

- The modular design allows you to choose a Pre-filter Low Mount or Ram High Mount design.
- Works with other popular Rugged Ridge® accessories like: Dual Battery Trays, Windshield Light Bars & Windshield Light Mounting Tabs.
- Installs with minor modification of the fender. Unlike other kits that require cutting large holes in the firewall, fender or hood!
- Includes lower air cleaner box that seals and mates to the factory air intake.

Modular XHD Snorkel

	Part #
Modular XHD Snorkel Low Mount, 07-11 Wrangler 3.8L	17756.06
Modular XHD Snorkel High Mount w/Ram Intake, 07-11 Wrangler 3.8L	17756.07
Modular XHD Snorkel Kit*, 07-11 Wrangler 3.8L	17756.20

*Includes Low Mount & Ram High Mount

2012+ 3.6L VERSION - IN DEVELOPMENT!

Want more horsepower, better throttle response, and improved acceleration?

A Rugged Ridge® Cold Air Intake System can boost your performance, while helping you keep extra cash in your wallet. Our polished aluminum mandrel bent intake tube replaces the restrictive factory air box to help improve fuel economy. A black powder coated heat shield separates the filter from engine heat, dirt and debris, as cold air is drawn through a high-flow conical air filter. Unlike other reusable air filters, our dry panel design never needs oiling, which keeps your mass airflow sensor from being damaged by excess oil! The simple bolt on installation gives you power you can feel, adding up to 10HP and 12ft lbs of torque, depending on application.

COLD AIR INTAKES FOR JEEP®



Rugged Ridge® Cold Air Intake Systems

	Part #
07-11 Wrangler 3.8L NEW	17750.06

*See <http://www.fueleconomy.gov/feg/maintain.shtml>
** Depending on kit

17750.06 for 07-11 Wrangler 3.8L

RUGGED RIDGE® THROTTLE BODY SPACER FOR 2007-11 JEEP® WRANGLER



The Rugged Ridge® Throttle Body Spacer raises the throttle body 1/2" above the intake manifold. The lift helps optimize power and performance by drawing in colder denser air. The large bore design allows your system to inhale a larger volume of air producing more horsepower and torque. It features solid aluminum construction with a slick anodized black finish, and is a bolt on performance adder for 3.8L engines.

SYNTHETIC AIR FILTER

Unlike other reusable air filters, our dry panel design never needs oiling, which keeps your mass airflow sensor from being damaged by excess oil! Rugged Ridge® performance high flow filters are made from a synthetic fabric and not cotton. Cotton filters are made porous and must be oiled to trap dirt and debris. But that oil reduces air flow through the filter and it can become easily clogged. Our filters are woven from synthetic fabric to allow maximum air flow and particulate filtration. Because our filters never need oiling, they can be cleaned easily with water instead of degreaser, reducing the cost of maintaining the filter over the lifetime of your vehicle. No oil = No fuss, no mess and improved performance!



Throttle Body Spacer

	Part #
07-11 Wrangler 3.8L NEW	17755.02

Air Filter

	Part #
Synthetic, Wrangler 07-11 3.8L and 2.8L Diesel, Wrangler 2012 3.6L NEW	17752.05

All images are subject to be representative. More detailed information is available online.

RUGGED RIDGE® HEAVY DUTY 8,500 LB WINCH

- Durable 5.5 HP Series Wound motor for long life and extra pulling power
- Tough 3 stage planetary gear box with a 172.8:1 gear ratio delivering power and reliability
- Includes 94' of 5/16" diameter wire rope and latched hook
- Automatic load holding brake system (in the drum brake system)
- Exclusive light mount roller fairlead included- allows for easy no-drill mounting of up to 2 off road lights!
- Tough stainless hardware is used on the body of the winch to eliminate rust
- Each winch includes a durable 12' all weather cable remote solenoid box that can be mounted in multiple positions (over cable or over motor) and angles to accommodate most winch bumpers including the Rugged Ridge® XHD Bumper System!
- Limited 3 year warranty against manufacturing defects



Exclusive Light Mount Roller Fairlead included with both wire cable winches

8,500LB LINE SPEED & AMP DRAW-FIRST LAYER for Wire Cable and Synthetic Rope Winches

Line Pull	Lbs	No Load	2000	4000	6000	8000	8500
Line Speed	Ft/min	37.2	18	13.1	10.2	8.2	7.2
Motor Current	amps	70	190	260	335	410	425



8,500 LB. Heavy Duty Winch with Steel Cable | Part #
8,500 LB Heavy Duty Winch with Steel Cable | 15100.01

RUGGED RIDGE® HEAVY DUTY 10,500 LB WINCH

- Durable 6.6 HP Series Wound motor for long life and extra pulling power
- Tough 3 stage planetary gear box with a 218:1 gear ratio delivering power and reliability
- Includes 94' of 23/64" diameter wire rope and latched hook
- Automatic load holding brake system (in the drum brake system)
- Exclusive light mount roller fairlead included- allows for easy no-drill mounting of up to 2 off road lights!
- Tough stainless hardware is used on the body of the winch to eliminate rust
- Each winch includes a durable 12' all weather cable remote solenoid box that can be mounted in multiple positions (over cable or over motor) and angles to accommodate most winch bumpers including the Rugged Ridge® XHD Bumper System!
- Limited 3 year warranty against manufacturing defects

ALL WEATHER 12' CABLE REMOTE INCLUDED WITH ALL WINCHES

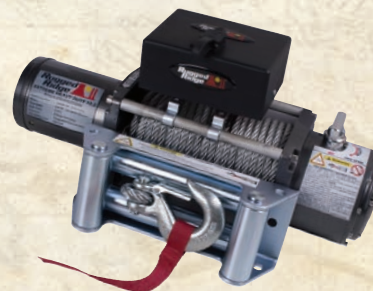

10,500LB LINE SPEED & AMP DRAW-FIRST LAYER for Wire Cable and Synthetic Rope Winches

Line Pull	Lbs	No Load	2000	4000	6000	8000	10500
Line Speed	Ft/min	29.5	14.4	11.9	9.85	8.7	7.2
Motor Current	amps	70	170	240	310	380	425

10,500 LB. Heavy Duty Winch with Steel Cable | Part #
10,500 LB Heavy Duty Winch with Steel Cable | 15100.10



RUGGED RIDGE® SYNTHETIC ROPE PERFORMANCE WINCHES!

We have taken the high quality features of our regular winch and replaced the steel cable with genuine Dyneema SK-75 Synthetic Rope for a lighter weight, high performance winch option. The synthetic rope used on Rugged Ridge® winches is custom designed for heavy duty use and combined with the included polished aluminum hawse fairlead and 12' hook, will provide the ultimate in pulling power.

Rugged Ridge® 8,500 Synthetic Rope Winch- 11/32" x 100', Breaking Force 16,550lbs

- Constructed with Dyneema SK-75 fiber from the Netherlands.
- Same high strength fabric used in ballistic body armor.
- Significantly stronger than same diameter steel cable and up to 40% stronger than Kevlar.
- 1/7 the weight of the same diameter wire rope.
- Will not splinter, kink or curl like wire rope & floats in water.
- Specially coated to be resistant to UV, abrasions, and chemical solvents.
- Heavy Duty 11/32" 12-strand braid with a breaking force of 16,550lbs
- Hawse fairlead included

ALL WEATHER 12' CABLE REMOTE INCLUDED FOR ALL WINCHES



8,500 LB Performance Winch with Synthetic Rope | Part #
8,500 LB Performance Winch with Synthetic Rope | 15100.02

ALL RUGGED RIDGE® SYNTHETIC WINCHES INCLUDE AN ALUMINUM HAWSE FAIRLEAD



Rugged Ridge® 10,500 Synthetic Rope Winch-3/8" x 94', Breaking Force 19,310lbs

- Constructed with Dyneema SK-75 fiber from the Netherlands.
- Same high strength fabric used in ballistic body armor.
- Significantly stronger than same diameter steel cable and up to 40% stronger than Kevlar.
- 1/7 the weight of the same diameter wire rope.
- Will not splinter, kink or curl like wire rope & floats in water.
- Specially coated to be resistant to UV, abrasions, and chemical solvents.
- Heavy Duty 3/8" 12-strand braid with a breaking force of 19,310lbs
- Protective sleeves keep line from overheating on winch drum.
- Hawse fairlead included

10,500 LB Performance Winch with Synthetic Rope | Part #
10,500 LB Performance Winch with Synthetic Rope | 15100.11

WARNING: Read and understand all instructions and related Warnings, Cautions and Notices before attempting to install or use your Rugged Ridge® winch.

WHY SYNTHETIC WINCH ROPE?

Stronger and lighter, the two key elements of Synthetic Rope that make it the choice of competition off road vehicles everywhere. Rugged Ridge® high strength synthetic Winch Rope is constructed from genuine Dyneema SK-75 fiber imported from the Netherlands. This revolutionary fiber is the choice of off-road enthusiast worldwide. It is stronger and lighter than wire rope and never kinks or splinters! Our synthetic line is woven from twelve UV-treated strands, resulting in increased strength, and a power to weight ratio unmatched by wire rope. Each synthetic rope comes with a protective sleeve that prevents it from over heating on the winch drum, black powder coated latched hook, stainless steel thimble, and is pre-terminated end for ease of installation. Synthetic rope does not store energy like steel cables, and in the event of a failure it is much less likely to result in severe injuries caused by the whiplash of broken wire rope.



- Significantly stronger than same diameter steel cable and up to 40% stronger than Kevlar.
- Same high strength fabric used in ballistic body armor.
- 1/7 the weight of the same diameter wire rope.
- Will not splinter, kink or curl like wire rope & floats in water.
- Protective sleeves keep line from overheating on winch drum.

Synthetic Winch Rope

	Part #
Synthetic Winch Rope 11/32" x 100', Breaking Force of 16,550 lbs, Each NEW	15102.10
Synthetic Winch Rope 3/8" x 94', Breaking Force of 19,310 lbs, Each NEW	15102.11

ALUMINUM HAWSE FAIRLEAD

This hawse fairlead will help guide the synthetic winch rope to and from the spool. Required for synthetic rope. Not recommended for steel rope.



Aluminum Hawse Fairlead

	Part #
Aluminum Hawse Fairlead, Each	11238.01

WINCH COVER

Keep your winch looking as good as the day you bought it with the Rugged Ridge® winch cover. Constructed of durable vinyl with reinforced grommets. Custom fit for Rugged Ridge® Winches



Rugged Ridge® Winch Cover

	Part #
Winch Cover, All Rugged Ridge® Winches NEW	15102.02

*Will not fit UTV winches

WINCH CABLE HANDLE



NEW!

The winch hook handle is the perfect solution for handling a winch cable. It is constructed of tough nylon webbing with a molded sure-grip handle. Perfect for getting a good solid grip of the winch hook when free spooling cable for a recovery and a safe way to respool your cable without endangering your fingers. Just slip your winch hook through the nylon webbing and you are ready to rock!

Winch Cable Handle

	Part #
Winch Cable Handle, Each NEW	15102.01

WINCH CABLE STOPPER



NEW!



Winch Cable Stopper

	Part #
Red, with Steel Cable or Synthetic Rope, Universal Application NEW	15102.05
Black, with Steel Cable or Synthetic Rope, Universal Application NEW	15102.06

LIGHT MOUNT ROLLER FAIRLEAD

Turn your roller fairlead into an off road light mount! This revolutionary new design allows for two off road lights to be easily mounted while not interfering with the winch operation.



11238.03

Light Mount Roller Fairlead

	Part #
Light Mount Roller Fairlead, Each NEW	11238.03

ROLLER FAIRLEAD LICENSE PLATE HOLDER



11238.05

If your state requires a front license plate, we have a solution for you. Instead of drilling holes in your bumper or risking not running a front plate, this easy to install license plate holder attaches to your winch roller fairlead. Simply bolt your license plate to the bracket and snap the holder in place. Your license plate is now securely mounted yet easily removable for winching.

Roller Fairlead License Plate Holder

	Part #
Roller Fairlead License Plate Holder, Each NEW	11238.05



NEW!

DUAL BATTERY TRAY

Outfitting a trail rig can add greater strain to the electrical system. Adding on a winch, air compressor, fog lights, driving lights, a spot light, electric fuel pump, and a stereo amp can really tax the battery. A great way to combat that strain to install dual batteries. This is especially true when using a winch, which can draw big amps for an extended period. These kits are designed to mount two batteries in place of the factory single battery location. The trays and brackets feature a black powder coated finish. These are mounting kits only and do not include any wiring. A suggested wiring diagram is included. The kit places the batteries side-by-side and may be used with lead acid or cylindrical-style sealed gel cell batteries.

Rugged Ridge® Dual Battery Tray

	Part #
07-11 Jeep® Wrangler NEW	11214.53

DUAL BATTERY RELAY KIT



NEW!

The Rugged Ridge® Dual Battery Relay Kit is the perfect companion to the Rugged Dual Battery Tray. This relay kit allows you to connect two batteries to your electrical system. Because the last thing you want when your out of the trail or headed to the beach is a dead battery.

Rugged Ridge® Dual Battery Relay Kit

	Part #
07-12 Jeep® Wrangler NEW	17265.01

RECOVERY GEAR

20,000 lbs Kit

- Durable Recovery Gear Bag.
- Heavy Duty 8" 20,000lb Snatch Block Pulley.
- Premium 3" x 30' 20,000lb Recovery Strap.
- Premium 3" x 6' 30,000lb Tree Trunk Protector Strap.
- Heavy Duty 9,500lb zinc coated pair of D-Rings.
- Winch Line Dampener.
- Pair of leather Recovery Gloves.

30,000 lbs Kit

- Durable Recovery Gear Bag.
- Heavy Duty 9" 30,000lb Snatch Block Pulley.
- Premium 3" x 30' 30,000lb Recovery Strap.
- Premium 3" x 6' 30,000lb Tree Trunk Protector Strap.
- Heavy Duty 13,500lb zinc coated pair of D-Rings.
- Winch Line Dampener.
- Pair of Leather Recovery Gloves.

The Rugged Ridge® Recovery Kit includes everything you need to help your buddy next time he gets stuck in the mud. The durable carrying case is filled with our most popular recovery products to make sure you can get out of those trouble spots quickly and safely. Each kit contains the following:



NEW!

Recovery Gear also sold separately.

Rugged Ridge® Recovery Gear Kit

	Part #
20,000 lb, Recovery Gear, Kit, Universal Application	15104.25
30,000 lb, XHD Recovery Gear Kit, Universal Application NEW	15104.28

Don't Need Everything In Our Recovery Kit? Customize Your Your Own And Get Just What You Need!

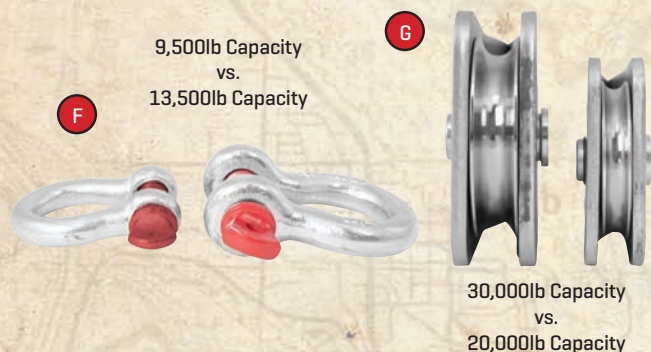

Rugged Ridge® Recovery Gear

	Part #
A Recovery Strap 3" x 30' 30,000 lbs, Each NEW	15104.01
A Recovery Strap 2" x 30' 20,000 lbs, Each NEW	15104.02
A Recovery Strap 4" x 30' 40,000 lbs, Each NEW	15104.03
B Tree Trunk Protector, 3" x 6' 30,000 lbs, Each NEW	15104.10
B Tree Trunk Protector, 2" x 6' 20,000 lbs, Each NEW	15104.11
C Recovery Bag, Each NEW	15104.40
D Recovery Gloves, Pair NEW	15104.41
E Winch Line Dampener, Each NEW	15104.43
F Heavy Duty 9,500 lb Zinc Coated D-Rings, Pair NEW	11235.01
F Heavy Duty 13,500 lb Zinc Coated D-Rings, Pair NEW	11235.03
G Heavy Duty 8" 20,000 lb Snatch Block Pulley, Each NEW	11235.10
G Heavy Duty 9" 30,000 lb Snatch Block Pulley, Each NEW	11235.11

TIRE REPAIR KIT

The Rugged Ridge® Tire Repair Kit is essential recovery gear for any road or trailside tire repair. The kit includes: 2 sturdy aluminum handles, 2 reamers, 2 needles, 2 Allen head wrenches, and 25 self vulcanizing tire plugs all stored in a heavy duty storage case. Be prepared for what ever the trail throws at you!



Rugged Ridge® Tire Repair Kit

	Part #
Tire Repair Kit, Each NEW	15104.51

OFF ROAD JACK HANDLE RETAINER STRAP

This handy Off Road Jack Handle Retainer Strap pulls taut to secure the jack handle to the jack and eliminates obnoxious rattles. Simply loop the strap around the jack handle and pull it tight and go! Fits most off road style farm jacks including Hi-Lift.



Off Road Jack Handle Retainer Strap

	Part #
Universal Application, Black NEW	13305.60

TIRE DEFLATOR KITS

Fully inflated tires are great for the road and gas mileage, but they deliver a washboard ride on the trail. Air down your tires for a softer ride and more tread grip. Rugged Ridge® offers two great kits to fit your lifestyle and budget. This adjustable tire deflator kit is made from 100% brass and are fully adjustable in 3 psi. increments. Once you find your desired setting you can lock the deflators where they bleed to the same tire pressure each and every time they are installed. So, you can deflate your tires quickly before heading out on the trail. The keychain tire deflator kit is made from stainless steel and connect together onto a key chain for ease of use!

Rugged Ridge® Tire Deflator Kits

	Part #
Adjustable Tire Deflator Kit, 4 Piece Kit NEW	15104.53
Keychain Tire Deflator Kit, 4 Pieces	15104.50



TRI FOLD RECOVERY SHOVEL

The Rugged Ridge® Tri Fold Recovery Shovel is a fully functional collapsible shovel that features two serrated edges for cutting or digging. The heavy duty black powder coated body is 23 inches when open and folds to a mere 9 inches. It can be stowed easily in any vehicle, but is still rugged enough for the toughest of jobs. Includes durable storage case.

Rugged Ridge® Tri Fold Off Road Shovel

	Part #
Tri Fold Off Road Shovel, Each	15104.42



HID LIGHTING

We mated the brilliance of High Intensity Discharge bulbs with the rugged construction of our traditional halogen off road lights. The result is more efficient and powerful beam better capable of illuminating the night sky. HID lights are 2½ times more powerful than halogen lights and draw 60% less current than a standard 100W fog light. Our 6" and 5" HID Lights are constructed with heavy duty stamped steel housings, and are available in corrosion resistant black or stainless steel finish. Rugged Ridge® lights feature waterproof connections, internal ballast, and a reinforced multi-directional mounting base. The lights are available individually or in kits containing a pre-terminated wiring harness, relay, impact resistant stone guards and illuminated dash switch.

- 5", 6", 7" HID light assemblies available.
- 12V 35W 4200K HID Bulb.
- Internal ballast - no external ignition ballast to install.
- 2½ times more powerful than halogen bulbs.
- Draws 60% less current than a standard 100W fog light.
- HID Lights include impact resistant stone guard.
- The average life of an HID bulb is 2000 hours, compared to 500-1000 hours for a halogen unit.



Lights are available individually.
All include impact resistant stone guards



Kits include a pre-terminated wiring harness, relay and illuminated dash switch



15205.51



15206.01



15205.63

HID Off Road Lighting	Single Light	2 Light Kit w/ Wiring Harness	3 Light Kit w/ Wiring Harness
6" Round, Black	15205.01	15205.51	15205.61
5" Round, Black	15205.02	15205.52	15205.62
7" Round, Black, Plastic	15205.03	15205.53	15205.63
5" Round, Black, Plastic	15205.04	15205.54	15205.64
6" Round, Stainless	15206.01	15206.51	15206.61
5" Round, Stainless	15206.02	15206.52	15206.62

HALOGEN LIGHTING

Designed, engineered, and tested to stand up to the rigors of off road use, our lights are constructed with heavy-duty stamped steel housings, and crystal glass lenses set in shock absorbent weatherproof rubber gaskets. The brilliant 12V 100 watt halogen bulbs slice through fog, rain or snow to help illuminate the road even under the toughest conditions. Available in Round, Rectangular and Slim housings in either a black or stainless steel finish to best suit your application. Slim lights feature a narrow profile just 2 13/16" thick! This sleek design allows them to be mounted in places most lights won't fit. They are perfect for windshield and grille mount light systems. The lights are available individually or in kits containing a pre-terminated wiring harness, relay, impact resistant stone guards (white stone guards with stainless, black with black) and illuminated dash switch.



15207.51

Rugged Ridge® Off Road Lights, 100W	Single Light	2 Light Kit w/ Wiring Harness	3 Light Kit w/ Wiring Harness
6" Round, Black	15207.01	15207.51	15207.61
5" x 7", Black	15207.05	15207.55	15207.65
6" Slim, Black	15207.10	15207.58	15207.68
6" Round, Stainless	15208.01	15208.51	15208.61
6" Slim, Stainless	15208.10	15208.58	15208.68

Slim lights feature a narrow profile - just 2 13/16" thick!



Rectangular lights give your vehicle a whole new look

Halogen Light Accessories	Part #
Off Road Light Cover, 6-Inch Black	15210.53
Off Road Light Cover, 6-Inch White	15210.54
Off Road Light Cover, 5x7-Inch Black	15210.55
Off Road Light Cover, 5x7-Inch White	15210.56
Off Road Light Cover, 6-Inch Black Slim	15210.57
Off Road Light Cover, 6-Inch White Slim	15210.58
Off Road Light Installation Harness, For Pair Of Lights	15210.62
Off Road Light Installation Harness, For Three Lights	15210.63
Halogen H3 Off Road Light Bulb, 100w Replacement	15210.82
Halogen H3 Off Road Light Bulb, 130w Replacement	15210.83

Crystal glass lenses set in shock absorbent weatherproof rubber gaskets.



Each lights includes an impact resistant stone guard.

Multi-directional mounting base allows you to focus light where you need it the most.

HID LIGHT ACCESSORIES



15210.50



15210.81



15210.80

Accessories/Replacement Parts

Accessories/Replacement Parts	Part #
HID Lighting Covers, 7",Smoked	15210.51
HID Lighting Covers, 6",Black	15210.50
HID Lighting Covers, 5",Black	15210.52
HID Lighting Installation Harness for a pair of lights	15210.60
HID Lighting Installation Harness for three lights	15210.61
Replacement HID Bulb for 5" and 6" lights	15210.80
Replacement HID Bulb for 7" lights	15210.81



ROCKER SWITCH HOUSING KIT

This housing kit allows you to mount 2, 3, or 4 switches to numerous dash locations by using a series of interlocking interchangeable pods.

Rocker Switch Housing Kit

Rocker Switch Housing Kit	Part #
Mounts 2,3 OR 4 Switches NEW	17235.20
Rocker Switch Housing Kit, Universal Application. Includes Four Interlocking Switch Housings and Four Different Color Rocker Switches	17235.89



17235.20

ROCKER PANEL SWITCHES

- Rocker Style Switch.
- Heavy Duty Marine Grade surpasses OE Specifications.
- Available in four great colors: Red, Blue, Green and Amber.
- Switch illuminated in the "ON" Position.
- Three post terminal, 20-amp design works with most aftermarket accessories.

Rocker Panel Switches

Rocker Panel Switches	Part #
Rocker Switch Amber	17235.01
Rocker Switch Red	17235.02
Rocker Switch Blue	17235.03
Rocker Switch Green	17235.04



17235.01

17235.03

17235.02

17235.04

LOWER CONSOLE SWITCH POD KIT

Rugged Ridge® Center Console Mount Switch Pod replaces your original equipment "filler plate" by simply popping the filler plate out and putting in the switch plate. Each plate will hold up to 4 switches and custom built for all 2007-2010 Jeep® Wranglers with an automatic transmission. This exciting new mounting plate looks great and places auxiliary switches in easy reach. Purchase the Switch Panel and 4 multi color Rocker Switches all together and save [See kit part number below.] Limited 3yr Warranty.



NEW!

Low Switch Panel Kit

Low Switch Panel Kit	Part #
07-10 Wrangler w/ Automatic Transmission. Includes Switch Pod and Four Rocker Switches NEW	17235.85

LOWER CONSOLE SWITCH POD

Rugged Ridge® Center Console Mount Switch Pod replaces your original equipment "filler plate" by simply popping the filler plate out and putting in the Switch Plate. Each plate holds up to 4 Switches. Custom built for all 2007-2010 Jeep® Wranglers with an Automatic Transmission. Limited 3 year warranty.



NEW!

Low Switch Panel Kit

Low Switch Panel Kit	Part #
07-10 Wrangler w/ Automatic Transmission, Black, Mounts Four Switches NEW	17235.55

RUGGED RIDGE® A-PILLAR SWITCH POD

Looking for a handy place to mount your accessory switches that doesn't require cutting or other modifications? The Rugged Ridge® A-Pillar Switch Pod has premolded cutouts to allow you to mount up to four aftermarket switches in easy reach on the driver's side A-pillar, and out of the way of the shifter handle. Our Pillar Pod has the textured molded finish just like the factory plastic pillar cover it replaces. It snaps into place just like the OE!



A-Pillar Switch Pod

A-Pillar Switch Pod	Part #
Wrangler 07-10 LH NEW	17235.56
Wrangler 07-10 RH NEW	17235.57
Wrangler 11-12 LH NEW	17235.58
Wrangler 11-12 RH NEW	17235.59

A-PILLAR SWITCH POD KIT

Includes Switch Pod and Four Rocker Switches

A-Pillar Switch Pod Kit

A-Pillar Switch Pod Kit	Part #
Wrangler 07-10 LH NEW	17235.86
Wrangler 07-10 RH NEW	17235.87
Wrangler 11-12 LH NEW	17235.88
Wrangler 11-12 RH NEW	17235.89



NEW!

FRONT BUMPER LIGHT BARS

Rugged Ridge® has engineered a durable and easy to install light bar that allows you to add auxiliary lighting to your factory Wrangler bumper. The light bar bolts to existing mounting holes and installs easily without cutting, drilling, or removing the bumper. With a few simple hand tools you will be able to install your light bar and mount up to three lights on your Jeep® while retaining your factory bumper. Lights not included.



11232.20, 2007-12 Wrangler



11138.20, 2007-12 Wrangler



Front Bumper Light Bars

	Part #
07-12 Wrangler, Textured Black, Each	11232.20
07-12 Wrangler, Stainless Steel, Each	11138.20

WINDSHIELD HINGE LIGHT BRACKETS

Special black powder coated or polished stainless brackets mount directly to the windshield hinge of your Wrangler. Allows for easy mounting of auxiliary lighting. Each bracket is custom designed for an exact mount and 07-12 models include a rubber gasket to protect the paint during installation/removal. Sold in pairs. Lights not included.



11027.03

Windshield Hinge Light Brackets

	Black	Stainless
07-12 Wrangler NEW	11027.03	11028.03

MOUNT A SET OF DRIVING LIGHTS ON YOUR HOOD CATCHES

Rugged Ridge® offers a complete light solution for your 2007-12 Jeep® Wrangler with our NEW Hood Mount Off Road Light Kit. This innovative product mounts a pair of 3" 55-watt Halogen Lights directly to your factory hood latches without drilling or vehicle modification. Each Kit includes textured black powder coated brackets, two 3" Halogen lights, a pre-terminated extended wiring harness, relay and an adhesive mounted switch for a complete light solution.



Hood Mounted Off Road Light Kit 2007-12 Wrangler

	Part #
Hood Mounted Off Road Lights, 3" Black, 2 Light Kit w/ Wiring Harness NEW	15207.70
Spare Light for Hood Mounted Light Kit NEW	15207.72

RUGGED RIDGE® JK WINDSHIELD LIGHT BAR

The Ultimate Light Bar for your Wrangler! This exciting new design has been created to give the durable look of a five tab light bar with features found nowhere else. Through extensive testing, this heavy duty light bar incorporates a special wind deflector below the light bar to dramatically reduce whistling and "buffeting" of your soft top. Each bar hugs the contour of your windshield providing a great look while not interfering with the use of your hard or soft top. Oversized 2" textured black tubing attaches to your windshield mounts with no drilling. Each Light bar has five light tabs for use with Rugged Ridge® Lighting options (fits up to five 7" lights). Each light bar has been specially developed to work with Rugged Ridge® Light mount brackets and/or Rugged Ridge® mirror relocation brackets. Special three piece design makes the packaging small for ease of shipping. This is truly the most advanced light bar on the market!

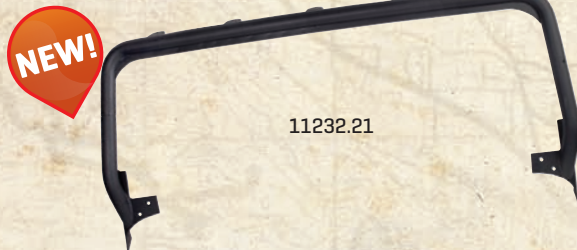

Windshield Light Bar

	Part #
Textured Black, Jeep® Wrangler [JK] 07-12, Each NEW	11232.21



XHD OVERRIDER LIGHT CLAMPS

Light mount brackets for use with XHD part numbers 11540.14, 11540.16 and any other 2'-2.5" bumper override/tubes. Easy mount design makes these a must for mounting Rugged Ridge® Lights to your bumper. Also available for smaller 1.5"-1.75" tube sizes. Sold as each.



Light Clamps

	Part #
2"-2.5" Over Rider Mount Bracket New	11503.82

OE JK FOG LIGHT

Stock replacement lens and housing assembly. Fits either side.



OE Fog Light

	Part #
Fog Light Assembly, Jeep® Wrangler [JK] 07-10 LH/RH	12407.12

EUROGUARD KITS

Complete front and rear headlight and taillight protection packages now available! Get the complete look all in one package.



Euroguard Kits

	Part #
Fog Lights, Black, 10 Piece, Wrangler [JK] 07-12 NEW Includes: Headlight, Side Marker, Turn Signal, Fog Light and Tail Light Guards	12496.02
W/o Fog Lights, Black, 8 Piece, Wrangler [JK] 07-12 NEW Includes: Headlight, Side Marker, Turn Signal, and Tail Light Guards	12496.03
Headlight Bezels and Grille Inserts, Black, 19 Piece, Wrangler [JK] 07-12 NEW Includes: Headlight, Side Marker, Fog light, Turn signal, Turn signal, Grille inserts and Headlight Trim	12496.05
Headlight Bezels and Grille Inserts, Black, 17 Piece, Wrangler [JK] 07-12 NEW Includes: Headlight, Side Marker, Turn signal, Turn signal, Grille inserts and Headlight Trim	12496.06
Fog Lights, Stainless Steel, 10 Piece, Wrangler [JK] 07-12 NEW Includes: Headlight, Side Marker, Turn Signal, Fog Light and Tail Light Guards	12496.08
Fog Lights, Stainless Steel, 10 Piece, Wrangler [JK] 07-12 NEW Includes: Headlight, Side Marker, Turn Signal, Fog Light and Tail Light Guards	12496.09
Headlight Bezels and Grille Inserts, Stainless Steel, 19 Piece, Wrangler [JK] 07-12 NEW Includes: Headlight, Side Marker, Fog light, Turn signal, Turn signal, Grille inserts and Headlight Trim	12496.10
Headlight Bezels and Grille Inserts, Stainless Steel, 17 Piece, Wrangler [JK] 07-12 NEW Includes: Headlight, Side Marker, Turn signal, Turn signal, Grille inserts and Headlight Trim	12496.11



12496.05



12496.06



12496.02



12496.03



12496.08



12496.09

FRONT BUMPER LIGHT BAR KITS



Front Bumper Light Bar Kits

	Part #
Bumper Mount HID Fog Kit , w 5-IN HID Fog Lights, 5 Piece, Black, Wrangler [JK] 07-12 NEW Includes: Bumper Light Bar, [3] 5-In HID Lights, and Wiring Harness with Switch	12496.12
Bumper Mount Slim Fog Kit , w Slim Fog Lights, 5 Piece, Black, Wrangler [JK] 07-12 NEW Includes: Bumper Light Bar, [3] 100 Watt Slim Lights, and Wiring Harness with Switch	12496.13



12496.04



12496.12

12496.13

WINDSHIELD LIGHT MOUNT KITS



Windshield Light Mount Kits

	Part #
Slim Fog Lights, 5 Piece, Black, Wrangler [JK] 07-12 NEW Includes: Black Windshield Light Mount Brackets, [2] 100 Watt Slim Lights & Wiring Harness w/ Switch	12496.04
100 Watt Fog Lights, 5 Piece, Stainless Steel Mounts with Black Lights, Wrangler [JK] 07-11 NEW Includes: Stainless Windshield Light Mount Brackets, [2] 100 Watt Slim Lights & Wiring Harness w/ Switch	12496.07



12496.07



11237.10 Lockable Spare Tire Mount Bike Carrier

LOCKABLE SPARE TIRE MOUNT BIKE CARRIER

This easy-to-use bike rack mounts to any emergency tire mounting studs. The bike rack carries 2 bikes directly off the spare tire. It is constructed of 2" powder coated steel tubing for maximum rust protection and durability. The bike clamp features rubber pads to protect your bike's finish. The carrier comes with 2 keys for the locking mechanism. Fits wheel off sets from 2-5/8" to 6". For All Jeep® Outside Spare Tire Applications

Bike Carrier	Part #
Spare Tire Mount Bike Carrier, Each	11237.10

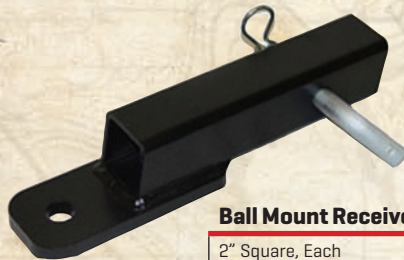

Ball Mount Receiver Hitch Part #
2" Square, Each 11237.02

2" RECEIVER HITCH

Includes clip and pin. Ball not included. For Jeep® use only. 2000-lb two rating, 200-lb tongue weight rating.

RECEIVER HITCH EXTENDER

Constructed from solid steel the extender lengthens your 2" receiver up to 12 inches! (Hitch mount accessories only - not tow rated)



Receiver Hitch Extender Part #
12" Extender, Each **NEW** 11580.50

2007-12 WRANGLER RECEIVER HITCH

Custom design bolts directly to factory mounting points on the rear of the vehicle, very similar design to the OE Receiver Hitch. Durable powder coat design sheds water and provides a long lasting rust free finish. Includes cutout for factory wiring harness mounting. Designed as a one-piece welded assembly for added strength, we built our hitch receiver to match the towing capacity of your Jeep®: 3,500-lb tow rating, 350-lb tongue weight rating with weight distributing equipment; otherwise 2000-lb tow rating, 200-lb tongue weight rating, 2" opening.

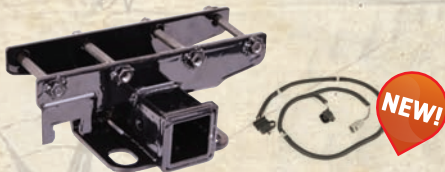

Receiver Hitch Part #
07-12 Wrangler, Each 11580.10

Tow Wiring Harness Part #
07-12 Wrangler, Each 17275.01

Hitch Kit Rear Part #
Hitch & Wiring, 07-12 Wrangler **NEW** 11580.51

RECEIVER SHACKLE BRACKET



This heavy-duty steel design fits into any 2" receiver box. It is rated up to 9,500 lbs. pulling capacity on evenly distributed straight pulls. Note: never exceed your receiver capacity. Not designed for towing. Does not include hitch pin.

Receiver Shackle Bracket Part #
All 2" Receivers, Each 11234.01*

*NEW 4-Color Packaging for 11234.01 is Part # 12680.13



HITCH BALL

Hitch Ball includes a matching mounting nut and lock washer. Pick from two standard sizes.

Hitch Ball Kit Part #
2" x 3/4" 11305.01
1-7/8" x 3/4" 11305.02

RECEIVER TOW HOOK

Heavy-duty black powder coated tow hook inserts into any 2" style hitch (does not include hitch pin, not designed for towing).

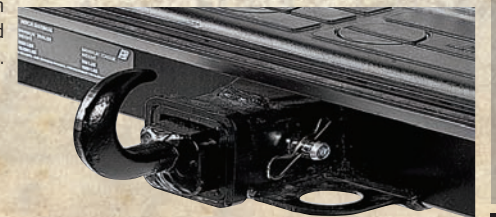

Receiver Tow Hook Part #
Fits All 2" Receivers, Each 11237.01



HOOD LIFT KITS

Eliminate the factory prop rod with a pair of gas charged hood lifts. This kit includes all the brackets and gas shocks needed to clean up the underhood appearance of your rig. This kit is also functional as the hood prop rod will no longer be in the way while working underneath the hood of your JK. Easy installation.



Hood Lift Kit Part #
07-12 Wrangler, Kit 11252.51

Service Replacement Shock Part #
07-12 Wrangler 11252.81

Designed by a dedicated team of Jeep® enthusiasts, the ORV™ suspension program is one of the most complete programs available. We have looked at each application in detail to provide the very best and most complete solution for your Jeep®. Since we focus the large majority of our attention on Jeep® vehicles, we know the ins and outs of what the best lift solution is depending on your individual needs. Below is a quick reference guide on the ORV™ program to make it easier to choose the lift you need for your particular need. Remember, all ORV™ Kits with shocks include a pair of neoprene wrapped grab handles and an Off Road Organizer for your glove box! **Welcome to ORV™ by Rugged Ridge®!**



Ken W.
Katterbach, Germany



Brian H.
Lonsdale, PA



Dave G.
Flowery Branch, GA

A FEW WORDS ABOUT PRODUCT SAFETY.

Your safety and the safety of other motorists is very important. Your Jeep® is an off road capable vehicle that readily lends itself to restoration and customization. In considering modifications to your Jeep's® suspension you are the person choosing the combination of suspension, wheels, tires, drive train and accessories that best fit your intended use. Likewise, you are the person responsible for the safety and legality of the vehicle you modify. In modifying your vehicle's suspension, balance your desired off road capabilities against how the vehicle may actually be used off road and on road.

It is not practical or possible to warn about all hazards associated with your Jeep® or modifying your suspension for improved off road capabilities. Start by familiarizing yourself with all vehicle manufacturers' instructions, warnings limited warranties and the instructions and warnings accompanying your aftermarket product.

To help you make informed decisions about safety; this catalog and the instructions accompanying our products have provided certain information in the form of "Notices" and "Warnings". This information alerts you to potential hazards that could hurt you or others.

NOTICE

This is a caution against anything which may cause damage to the vehicle or its equipment if the caution is ignored. The Notice includes information about how you can avoid or reduce those risks.

WARNING

This is a signal telling you that you CAN be KILLED or SERIOUSLY HURT if you don't follow the Warning. The Warning includes information about what you must or must not do in order to reduce the risk of injury to yourself and others.

CAUTION

This is a signal telling you that you or others CAN be HURT if you don't follow the instruction. The Caution includes information about how you can avoid those risks.

WARNING HIGHER ROLLOVER RISK

Modifying the suspension of your vehicle to improve off road capabilities involves certain risks. The modified vehicle may handle differently than as factory equipped including increased ride-height; reduced lateral stability and risk of roll-over or other accident. Also, owner's choice of larger tire and wheel combinations may require additional braking force or increased stopping distances.

- Failure to drive this vehicle safely may result in serious injury or damage. Avoid sharp turns or abrupt maneuvers. Do not drive the vehicle under any speed or maneuvering conditions which may cause the vehicle to trip, roll, lose traction or compromise your ability to safely brake in an emergency.
- Familiarize yourself with all vehicle manufacturers and Rugged Ridge® warnings, instructions and limited warranties before driving this modified suspension vehicle. Follow recommended maintenance procedures and routinely inspect your vehicle components for unusual wear or off road damage.
- Rugged Ridge® does not recommend combined use of body lifts with suspension or other lift devices or modification, alteration or fabrication of any Rugged Ridge™ suspension product to achieve additional lift. Also be aware that most states have restrictions on height modifications for vehicles used on road. Consult your vehicle owners manual, limited warranties, the instructions and warnings accompanying this product and state law before undertaking these modifications or using your modified suspension vehicle on road. A summary of current regulations affecting modified suspension vehicles is available from www.SEMA.org.
- Always wear seat belts and/or appropriate off road restraints, reduce your speed, tread lightly® and safely enjoy your off road vehicle.



What to Buy:

When looking at which kit is best for your application you need to determine two important things: size of tire and use of vehicle. On the 2007-12 Wrangler JK, 2.5-3.5" coil kit is designed for up to a 34" x 12.5" x 16" tire and moderate off road use. The 4"-5" coil kit is designed for more severe off road use and up to a 35" x 12.5" x 16" tire.

ORV™ 2.5"-3.5" Coil Spring Lift - With shocks part # 18415.50

- The most complete kit available on the market for JK.
- Includes four powder coated, E-coated 5160H hot rolled bar, 5/8" coil springs that are set to factory rates.
- By using 5160H hot rolled bar, the ORV™ Springs keep their memory, eliminating any possibility of future sag.
- Setting coil springs to factory rates gives you the best on road ride possible and the ability to use a larger tire.
- Each kit includes a rear track bar brace to strengthen the original track bar mount. An ORV™ exclusive!
- 4-Door JK's will get on average a 2.5" lift. Two door models will get up to a 3.5" lift. All lifts are dependent on specific Jeep® characteristics and additional parts being put on the vehicle [bumpers, winch, hard tops, soft tops etc.].
- ORV™ kits with shocks include a pair of Neoprene Wrapped Grab Handles and an Off Road Organizer!



JK 2.5"/3.5" Lift Kit

ORV™ 4"-5" Coil Spring Lift - With shocks part # 18415.60

- Get off road performance while not sacrificing on road ride.
- Includes 4 powder coated, E-coated 5160H hot rolled bar 5/8" coil springs, set to factory rates for longer life and better ride!
- Each kit includes a rear track bar brace to strengthen the original track bar mount. A must for off road performance on a JK.
- Kit includes sway bar disconnects for more articulation off road.
- ORV™ uses tough, over built extended control arms for added strength and higher performance. Each arm has a beefy 3/16" wall thickness and each end is tapered before welding. This extra heavy-duty design ensures a long life both on and off road.
- In most cases control arms are longer than factory to adjust for caster. This is not always true for other brand lifts! Each arm bushing can be easily greased without removing the arm from the vehicle.
- 4-Door JK's will get on average a 4" lift. Two door models will get up to a 5" lift. All lifts are dependent on specific Jeep® characteristics and additional parts being put on the vehicle [bumpers, winch, hard tops, soft tops etc.].
- Due to the changed pinion angle, we highly recommend a new drive shaft be installed when using any 4" or greater lift kit on a 4-Door Wrangler. A new drive shaft will be required on any 2007-12 2-Door Wrangler due to the shorter wheel base.
- All 4" Kits require a drop pitman arm.
- ORV™ kits with shocks include a pair of Neoprene Wrapped Grab Handles and an Off Road Organizer!



JK 4"/5" Lift Kit



18006.55 Pitman Arm

07-12 Jeep® Wrangler JK/Rubicon, 4WD [2 & 4-Door models]

	Kit w/o Shocks	Kit w/ Shocks	Max Tire Size HxWxD	Max Wheel Offset	Est. Install Time
2.5"-3.5" Lift, 07-12 Jeep® Wrangler, 2 & 4-Door	18401.50	18415.50	34"x12.5"x16"	4.5"	6 Hrs
4"-5" Lift, 07-12 Jeep® Wrangler, 2 & 4-Door*	18401.60	18415.60	35"x12.5"x16"	4.5"	8 Hrs

Note: due to vehicle weight, the 2-Door models may receive an additional 1" lift over 4-Door models

* Will require a drop pitman arm 18006.55. Sold Separately

18401.50 Kit includes: (4) coil springs, rear track bar bracket, rear bump stop bracket, rear track bar brace, hardware kit

18401.60 Kit includes: (4) coil springs, (2) lower front links, (2) lower rear links, (2) rear bump stop brackets, (2) rear bump stop spacers, front track bar bracket, rear track bar bracket, (2) front double disconnect end links, (2) rear extended sway bar end links, rear track bar brace, hardware kit

CAUTION!
CAUTION: Rugged Ridge® recommends use of wheel spacers with all suspension lifts to reduce risk of roll over or other accident associated with modifying ride height for increased off road capabilities. See additional product safety information and WARNINGS at back of catalog.

COIL SPRING KITS

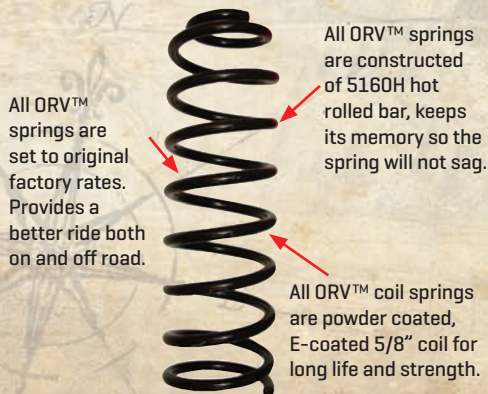

POLY BUSHINGS

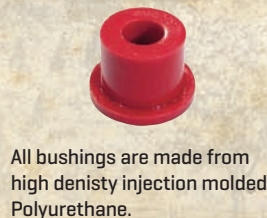

END LINKS



BRACKET/BRACES

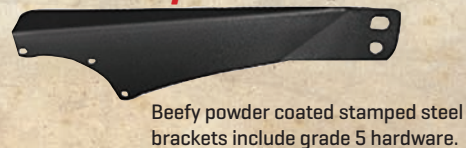

KNOW YOUR ORV™ KIT

All images are subject to be representative. More detailed information is available online.

ORV™ SHOCKS

ORV™ only uses nitrogen charged gas shocks for all their kits. Though a little more money, the nitro gas shock in combination with the ORV™ kits provide a better ride both on and off road. By using an ORV™ lift kit and matching gas shocks, you optimize the suspension's capabilities giving you a better ride both on and off road. Another advantage to Nitro gas shocks is their ability to prevent body roll. This is extremely important, as body roll will kick in the ESP sensors on later model Jeeps®, which will shut the vehicle down.

ORV™ shock features include:

- 150 PSI pressurized Nitrogen gas
- Internal valving - the internal orifice will rotate when the piston moves more than 2" - automatically adjusts to make the ride as smooth as possible
- Twin tube construction to lower heat build up and protect the shock from off road obstacles
- Constructed to ORV™ specifications by a leading Shock manufacturer
- Bonded Iron 14mm piston with extra chroming - provides for a longer, rust free life
- Includes polyurethane bushings and a black shock boot
- Limited lifetime warranty on the shocks



ORV™ Shocks

	Front	Extended	Collapsed	Rear	Extended	Collapsed
ORV™ Nitrogen Series Shock, 07-12 Jeep® Wrangler 2-Door, 3.5" Lift, 07-10 Wrangler 4-Door 2.5" Lift	18465.09	22.75"	13.54"	18465.10	25.35"	15.05"
ORV™ Nitrogen Series Shock, 07-12 Jeep® Wrangler 2-Door, 5" Lift, 07-10 Wrangler 4-Door 4" Lift	18465.11	26.79"	15.56"	18465.12	28.38"	16.65"

COLORED SHOCK BOOTS

Add a splash of color to your rig with colored shocks boots from Rugged Ridge®. These durable shock boots keep mud and debris from prematurely ruining your shocks and they look great too! Works on ORV™ Nitrogen Shocks and most other brands as well! Sold each.



ORV™ Shock Boots

	Part#
Shock Boot, Black, ORV™ Suspension, Universal Application NEW	18479.50
Shock Boot, Red, ORV™ Suspension, Universal Application NEW	18479.51
Shock Boot, Blue, ORV™ Suspension, Universal Application NEW	18479.52

ORV™ STEERING STABILIZERS

ORV™ recommends upgrading your current steering stabilizer or adding a stabilizer on all lifted Jeep® vehicles. The ORV™ Steering stabilizer dampens out the roughness of the highway and the vibration from running larger tires and wheels. ORV™ Hydraulic Stabilizers also make it easier to move those larger tires and wheels both on and off road. These noticeable handling improvements are well worth the small investment!



ORV™ Steering Stabilizers

	Part#
ORV™ Hydraulic Series Steering Stabilizer, 07-12 Jeep® Wrangler 2 & 4-Door	18475.03



CV EQUIPPED DRIVE SHAFTS FOR 07-12 WRANGLERS

Reduce or eliminate driveline vibration with a CV-equipped driveshaft. Constant Velocity (CV) joints use two U-joints (double cardan style) in the place of a single U-joint. This smooths out the driveline angle and reduces vibration due to extreme lifts or driveline changes. Works with stock to 6" lift.

CV Equipped Drive Shafts

	Part #
07-12 Wrangler, Front 2/4-Door	16592.22
07-12 Wrangler, Rear 2-Door	16592.21
07-12 Wrangler, Rear 4-Door	16592.20



16592.21 CV Equipped Rear Drive Shaft for 07-12 Wrangler 2-Door

ORV™ SUSPENSION SYSTEMS BY RUGGED RIDGE® LIMITED LIFETIME WARRANTY

Your Omix-Ada® /Rugged Ridge® product is covered by the Lifetime Limited Warranty explained below that gives you specific legal rights. This limited warranty is the only warranty Omix-Ada® /Rugged Ridge® /ORV™ makes in connection with your product purchase. Parts sold by Omix-Ada® or Rugged Ridge® but supplied by other vendors are exclusively warranted by the vendor supplying the part. Omix-Ada® neither assumes nor authorizes any vendor, retailer or other person or entity to assume for it any other obligation or liability in connection with this product or Limited Warranty.

What is covered? Subject to the terms, exclusions and limitations herein and with respect only to products first sold in the United States, Omix-Ada® warrants to the initial retail purchaser only that its Rugged Ridge® suspension kits, and ORV™ shocks and stabilizers shall be free of defects in material and workmanship for so long as the initial retail purchaser owns the vehicle on which these products were originally installed. All other express or implied warranties are hereby disclaimed. Your warrantor for these parts is Omix-Ada®, Inc., 460 Horizon Dr., Suite 400 Suwanee, GA 30024. Omix-Ada® reserves the rights to: [a.] require proof of purchase as a condition of this Limited Warranty, [b.] make future revisions to its Limited Warranty without prior notice.

What is not covered? Your Omix-Ada® /Rugged Ridge® /ORV™ Limited Warranty does not cover any Rugged Ridge® /ORV™ suspension systems that are used or combined with non-ORV™ suspension components. Furthermore, ORV™ suspensions not installed with ORV™ or other recommended shock absorbers may void the Limited Warranty. Products that wear out or fail due to the use of larger tires or wheels are not covered by this Limited Warranty. Your Omix-Ada® Limited Warranty further does not cover products or parts supplied to Omix-Ada® by outside vendors or products, parts or vehicles Omix-Ada® determines to have been damaged by or subjected to: Installation damage, alteration, modification or failure to maintain.

- Normal wear and tear (bushings, tie-rod ends, etc.). Scratches or defects in product finishes (powder coating, plating, etc.) or damage due to shipping.
- Damage arising or related to non- Omix-Ada® /Rugged Ridge® /ORV™, including but not limited to any vehicle's electronic stability system, related components or other vehicle systems.
- Racing or other vehicle competitions or contests. Accidents, impact by rocks, trees, obstacles or other aspects of the environment.
- Theft, vandalism or other intentional damage.
- Products used in application other than those recommended in the current /Rugged Ridge® /ORV™ catalog or the instructions accompanying your Rugged Ridge® /ORV™ product.

Remedy Limited to Repair / Replacement. The exclusive remedy provided hereunder shall, upon Omix-Ada® inspection and at Omix-Ada®'s option, be either repair or replacement of product or parts covered under this Limited Warranty. Customers requesting warranty consideration on Omix-Ada® branded parts (including Rugged Ridge® and ORV™) should first contact the independent distributor from whom you purchased your part to obtain a Returned Goods Authorization number. All removal, shipping and installation costs are customer's responsibility. Customers requesting warranty consideration on non-Omix-Ada® branded parts should refer to the manufacturers' Limited Warranty and contact them directly. If a replacement part is needed before the Omix-Ada® part can be returned, you must first purchase the replacement part. Then, if Omix-Ada® deems the part warrantable, you will be credited the purchase price.

Other Limitations - Exclusion of Damages - Your Rights Under State Law

- In consideration of the purchase price paid, neither Omix-Ada® nor any independent Omix-Ada® distributor/licensee are responsible for any time loss, rental costs, or for any incidental, consequential, punitive or other damages you may have or incur in connection with any part or product purchased. Your exclusive remedy hereunder for covered parts is repair/replacement as described above.
- This Limited Warranty gives you specific rights. You may also have other rights that vary from state to state. For example, while all implied warranties are disclaimed herein, any implied warranty required by law is limited to the terms of Limited Warranty described above. Some states do not allow limitations of how long an implied warranty lasts and /or do not allow the exclusion or limitation of incidental or consequential damages, so the limitations and exclusions herein may not apply to you.



Chantelle K.
Lusby, MD



Ricky T.
Birmingham, AL

©Omix-Ada®, Inc. 10.1.2011.
All Rights Reserved.

All images are subject to be representative. More detailed information is available online.

DRIVETRAIN ENGINEERING PERFECTED

Are you looking for an axle or ring and pinion rugged enough to match your off the beaten path sense of adventure? Alloy USA® axle shafts and Precision Gear® ring & pinions have been propelling muscle cars, trucks and four wheel drive vehicles down highways, drag strips, back roads and over the world's roughest terrain for nearly a decade. With the recent asset and intellectual property purchase of Alloy USA® and Precision Gear® by Ultra Axle LLC, an affiliate of Omix-Ada® Inc., these two brands are now backed by an industry leading, financially strong company that will be there for you in the long haul. As a member of the Omix-Ada® group of companies Alloy USA® and Precision Gear® will provide the service and support you demand!

The dedicated team of Alloy USA® and Precision Gear® engineers have developed, tested, raced and trail ridden each of our products until they were perfected. We marry the mechanics of engineering with the art of manufacturing to produce the finest in drivetrain solutions. High tensile strength 4340 Chromoly is heat-treated, tempered and induction hardened to produce these heavy-duty axles that are up to 40% stronger than stock. We use the latest splining technology to produce splines that are stronger than traditional cut splines. The shafts are then precision CNC machined and magnaflux inspected for cracks before receiving the Alloy USA® logo and a slick black anodized or natural finish.

Why have we put so much time and energy into developing our Axle Shafts and Ring & Pinions? Because horsepower is useless if you can't get it to the ground. We take pride in engineering solutions and prove it by backing each product with an industry leading warranty. Each axle is covered by our exclusive 10-year limited warranty and each ring and pinion is covered by a 5-year limited warranty so you can drive with confidence!



THE BEST WARRANTY IN THE BUSINESS

Alloy USA®/Precision Gear® Limited Warranty

Your Alloy USA® or Precision Gear® product is covered by the Limited Warranty explained below that gives you specific legal rights. This limited warranty is the only warranty Ultra Axle® LLC (the distributor/warrantor of these products) makes in connection with your purchase. Ultra Axle® LLC neither assumes nor authorizes any vendor, retailer or other person or entity to assume for it any other obligation or liability in connection with its products or Limited Warranty.

What is covered? Subject to the terms, exclusions and limitations herein and with respect only to products first sold in the United States, Ultra Axle® LLC warrants to the initial retail purchaser only that products sold under its Alloy USA® and Precision Gear® trademarks including Axle Shafts, Ring and Pinions, Installation Kits, Jeep® Overhaul Kits, Alloy USA® X Joints and Differential Covers shall be free of defects in material and workmanship for the Limited Warranty term/duration described below. This Limited Warranty shall be measured from the date of initial retail purchase, extends only to the initial retail purchaser and is not transferable. All other express or implied warranties are hereby disclaimed. Your warrantor for these parts is Ultra Axle® LLC, 460 Horizon Dr., Suite 400 Suwanee, GA 30024 (770-614-6101). Ultra Axle® reserves the right to: [a.] require proof of purchase as a condition of this Limited Warranty, [b.] make future revisions to its Limited Warranty without prior notice.

Duration of Limited Warranty by Product Line

Alloy USA®, front and rear axles- **10 Year Limited Warranty**

Precision Gear® and Alloy USA® Ring and Pinions- **5 Year Limited Warranty**

Jeep® Overhaul kits, Alloy USA® X Joints, Tube Seals, Differential Covers, Differential Cable Lock Kits, Wheel Spacers, Transfer Chain Kits, Yoke Conversion Kits & Hub Conversion Components - **3 Year Limited Warranty**

What is not covered: Your Alloy USA®, Precision Gear® Limited Warranty does not cover damage or claims to any component, vehicle or person other than Alloy USA® or Precision Gear® parts purchased by the initial retail purchaser. Your Alloy USA®, Precision Gear® Limited Warranty does not cover damage or claims to any component, vehicle or person Ultra Axle® LLC determines to have been damaged by or subjected to:

- Installation damage, alteration, modification, misuse or failure to maintain.
- Products used in application other than those recommended in the current Alloy USA®/Precision Gear® catalog or the instructions accompanying your Alloy USA® Precision Gear® product.
- Normal wear and tear/product life deterioration, scratches or defects in product finishes (powder coating, plating, etc.) or damage due to shipping.
- Damage arising or related to non- Ultra Axle® LLC products including but not limited to any vehicle's electronic stability system, related components or other vehicle systems.
- Accidents, impact by rocks, trees, obstacles or other aspects of the use environment.
- Theft, vandalism or other intentional damage.

Remedy Limited to Repair / Replacement. The exclusive remedy provided hereunder shall, upon Ultra Axle® LLC inspection and at Ultra Axle® LLC option, be either repair or replacement of the Ultra Axle® LLC parts covered under this Limited Warranty. Customers requesting warranty consideration should first contact the independent distributor selling your part to obtain a Returned Goods Authorization number. All removal, shipping and installation costs are customer's responsibility. If a replacement part is needed before the Ultra Axle® LLC part can be returned, you must first purchase the replacement part. Then, if Ultra Axle® LLC determines the part warrantable, you will be credited the purchase price of that part.

Other Limitations - Exclusion of Damages - Your Rights Under State Law

- In consideration of the purchase price paid, neither Ultra Axle® LLC nor any independent distributor are responsible for any loss of use or time, rental costs, or for any incidental, consequential, punitive or other damages you may have or incur in connection with your vehicle or any Ultra Axle® LLC product. Your exclusive remedy for Ultra Axle® LLC parts covered hereunder is repair/replacement as described above.
- This Limited Warranty gives you specific rights. You may also have other rights that vary from state to state. For example, while all implied warranties are disclaimed herein, any implied warranty required by law is limited to the duration and other enforceable terms of Limited Warranty described above. Some states do not allow limitations of how long an implied warranty lasts and /or do not allow the exclusion or limitation of incidental or consequential damages, so the limitations and exclusions herein may not apply to you.

© Ultra Axle® LLC Axle LLC. 1.3.2010. All Rights Reserved. Jeep® is a registered trademark of Chrysler LLC. Ultra Axle® LLC is an independent aftermarket vendor not affiliated with any vehicle manufacturer. Pro Gear® and UltraLite Gears and Differentials® are additional trademarks of Ultra Axle® LLC.



Chrysler®, Chevrolet®, Dodge®, GM®, Ford®, Jeep®, International® & other names used here are trademarks of their respective owners and are used within this publication for identification purposes only. Alloy USA® is not affiliated with these companies. The information in this catalog is believed to be correct at the time of publishing. The publisher is not responsible for any losses, direct or indirect, that are the result of any information within this publication. Alloy USA® and Precision Gear® and their corresponding logos are trademarks of Ultra Axle®, LLC. OMIX-ADA® and its corresponding logo are registered trademarks of OMIX-ADA®, Inc.

®Registered 2010, Ultra Axle®, LLC, all rights reserved.



FRONT AXLE KITS

High tensile strength 4340 Chromoly is heat-treated, tempered and induction hardened to produce these heavy-duty axles that are up to 40% stronger than stock 1040 axles. Each axle shaft is backed by Alloy USA®'s exclusive ten-year warranty! We use the latest splining technology to produce splines that are stronger than traditional cut splines. The shafts are then precision CNC machined and magnaflux inspected for cracks before receiving a slick black anodized finish. Our front axle shaft kits include everything you need to complete the job: both passenger and drive side inner and outer axle shafts, seals, U-joints and clips.

JEEP® COMPLETE INNERS/OUTERS WITH U-JOINTS & CLIPS

Application	Part #	Inner	Outer	Ring
Jeep® Wrangler (JK) 07-12, Dana 30 27-Spline Kit NEW	12152	27	32	D30
Jeep® Wrangler (JK) Rubicon 07-12, Dana 44 30-Spline Kit NEW	12155	30	32	D44



PERFORMANCE REAR AXLE KITS FOR JEEP®

High tensile strength 4140 Chromoly is heat-treated, tempered and induction hardened to produce these heavy-duty axles that are up to 35% stronger than stock 1040 axles. Alloy USA® uses the latest cold rolled splining technology, to produce splines that are stronger than traditional cut splines. Our shafts are covered by an exclusive 10-year warranty! Rear axle shaft kits include everything you need for your installation: both passenger and drive side shafts, seals, bearings and wheel studs. Upgraded spline counts for Jeep® applications: Dana 35 spline upgrades from 27 splines to 30 splines. Dana 44 spline upgrades from 30 splines to 33 and 35 splines.

Jeep® 2 Axles - Bearings - Seals - Wheel Studs

	Part #	Spline	Ring
Jeep® Wrangler (JK) 07-12, Dana 44 Grande 30-Spline Kit NEW	12156	30	D44
Jeep® Wrangler (JK) 07-12 Rubicon, Dana 44 Grande 32-Spline Kit NEW	12158	32	D44



PERFORMANCE REAR AXLE SHAFTS

Rule #1: If it broke it needed to be upgraded. For less than the cost of an original replacement axle shaft you can upgrade to an Alloy USA® performance shaft. Each axle is heat-treated, tempered and induction hardened to have twice the tensile strength than stock and is up to 35% stronger. We use the latest splining technology, to produce splines that are stronger than traditional cut splines.

Jeep® Axle Shafts, Sold Individually. Wheel Bearings, Seals, & Wheel Studs Available Separately

	Part #	Hollander	Spline	Length	Side	Ring
Jeep® Wrangler (JK) 07-12, Dana 44, LH/RH, 30-Spline NEW	21204C	NA	30	31.49"	LH/RH	D44
Jeep® Wrangler Rubicon (JK) 07-12, Dana 44, LH NEW	21205C	NA	32	30.79"	LH	D44
Jeep® Wrangler Rubicon (JK) 07-12, Dana 44, RH NEW	21206C	NA	32	32.165"	RH	D44

All images are subject to be representative. More detailed information is available online.

Wrangler 07-12

JEEP® RING & PINIONS

These affordable high strength gear sets come in all the popular ratios to satisfy everyone's gearing needs. Oversized tires require higher ring & pinion ratios to restore performance. Made from high quality 8620 forgings and Gleason gear cutting technology, these gears are made to last. Complete installation kits are available separately to complete the job. Exclusive 5-year warranty. Available in 3.73, 4.10, 4.56, 4.88, 5.13 and 5.38 ratios.



NEW!



Ring & Pinions

	Ratio	Part #
FRONT		
Wrangler (JK) 07-12, Front Dana 30, 3.73 Ratio NEW*	3.73	D30373RJK
Wrangler (JK) 07-12, Front Dana 30, 4.10, Ratio NEW*	4.10	D30410RJK
Wrangler (JK) 07-12, Front Dana 30, 4.88 Ratio NEW*	4.88	D30488RJK
Wrangler (JK) 07-12, Front Dana 30, 5.13 Ratio NEW*	5.13	D30513RJK
Wrangler (JK) 07 [w/ Trulok] 08-12 All, Front Dana 44, 4.10 Ratio NEW*	4.10	D44410RJK
Wrangler (JK) 07-12, Front Dana 44, 4.88 Ratio NEW*	4.88	D44488RJK
Wrangler (JK) 07-12, Front Dana 44, 5.13 Ratio NEW*	5.13	D44513RJK
Wrangler (JK) 07-12, Front Dana 44, 5.38 Ratio NEW*	5.38	D44538RJK
REAR		
Wrangler (JK) 07-12, Rear 7/16 Bolts, Dana 44, 4.10 Ratio NEW*	4.10	D44410JK
Wrangler (JK) 07-12, Rear Dana 44, 4.88 Ratio NEW*	4.88	D44488JK
Wrangler (JK) 07-12, Rear Dana 44, 5.13 Ratio NEW*	5.13	D44513JK
Wrangler (JK) 07-12, Rear Dana 44, 5.38 Ratio NEW*	5.38	D44538JK

*2012 and up models may require an aftermarket programmer to sync the new gear ratio to the transmission controller

RING & PINION MASTER INSTALLATION & OVERHAUL KITS FOR JEEP®

These great kits offer all the components you will need to complete your differential rebuild or ring & pinion installation. Complete with bearings, pinion seals, pinion shims, crush sleeve, pinion nut, ring gear bolts and marking compound.



Ring & Pinion Master Installation & Overhaul Kits

	Part #
Wrangler (JK) 07-12, Dana 30, Front (NEW)	352050
Wrangler (JK) 07-12, Dana 44, Front (NEW)	352051
Wrangler Rubicon (JK) 07-12, Dana 44, Rear (NEW)	352052
Wrangler X, Sahara (JK) 07-12, Dana 44, Rear (NEW)	352053

HD DIFFERENTIAL COVERS

Indestructible! You won't break these covers, we guarantee it. Made from either 3/8" cast steel or 5/16" stamped steel, painted black inside and out, these heavy-duty covers are designed to protect your differential and all its working parts for as long as you own your vehicle. These indestructible covers have been ".44 caliber tested" - if they can take a bullet at point blank range (don't try this at home!), they can take all that the trail has to offer. Available for most popular Dana differential types and include extra reinforcement protection for the fill plug area. All mounting hardware and instructions are included for ease of installation.

CAST



STAMPED



WHEEL SPACERS



NEW!

Wheel Spacers

	Width	Bolt Pattern	Part #
Jeep® Wrangler 2007-2012 NEW	1.50"	5 on 5.0"	11300

ALLOY USA® FRONT AXLE X-JOINT COLD FORGED · SERVICEABLE

Front Axle X-Joint

	Part #
Heavy Duty Alloy X-joint, Complete U-joint With Bearings (760 Style) Replaces 5-297X/5-760X, 07-12 Wrangler Dana 30 NEW	11500

Now a serviceable U-joint for Dana 44 applications is available to you. Replace your 760X U-joint with Alloy USA's new X-joint!

NEW!



OTHER U-JOINTS

Direct OE replacement



Other U-Joints

	Part #
U-Joint, Dana 44 Front, Jeep® Wrangler (JK) Rubicon 07-12 NEW	16525.08

ALLOY USA® AXLE TUBE SEALS

Keep water, mud and debris from entering your front axle housing. These CNC machined aluminum housings feature two seals to provide double protection from the crud.

Note: Must upgrade to 1 pc 30 spline grand axle. For use with all grande 30 spline axle upgrades & Rubicon Dana 44's.



Axle Tube Seals

	Part #
07-12 Wrangler w/ Grande Axles (JK) Dana 30 or 44 front axle (2) NEW	11105 (RED) 11106 (BLACK)
Replacement Inner Seal For 11105 and 11106 NEW	11109

FAN PHOTOS

facebook.com/ruggedridge



AJ G. - GA



TAMAR K. - MARTINEZ, GA



FRED P. - GA



DOUG W. - NORTHFIELD, NJ



DUSTIN S. - CEDAR RAPIDS, IA



BRIAN T. - LOGANVILLE, GA



JON & BRANDON - MARTINSVILLE, NJ



EUGENE D.



TOMMY F.



DUSTIN H. - HOUSTON, TX



JONATHAN M.



NICHOLAS S.



MARK & TINA H. - ATTICA, IN



PHIL S. - CASA GRANDE, AZ



2012 Catalog - 2007-2012 Wrangler (JK) Model - Part # 12511.01



DESIGNED TO BE A WHOLE NEW LOOK WHILE BEING EXTREMELY LIGHT WEIGHT!

XHD ALUMINUM BUMPER SYSTEM

FOR 07-12 JEEP® WRANGLER

SEE PAGES J9-J10 FOR MORE INFO & APPLICATIONS

SPECIAL ALUMINUM OVER-RIDER WITH FRONT SLOPE

JK WINCH PLATE - SPECIAL DESIGN FOR THIS BUMPER

ALUMINUM STUBBY BUMPER ENDS

ALUMINUM CENTER SECTION WITH STEEL D-RINGS



XHD ALUMINUM REAR INCLUDES:

- XHD BUMPER PODS
- XHD CENTER STEP



FIND US ON FACEBOOK

FACEBOOK.COM/RUGGEDRIDGE



OMIX-ADA.COM | RUGGEDRIDGE.COM | OUTLANDAUTOMOTIVE.COM | ALLOYUSA.COM | PRECISIONGEAR.COM
OMIX-ADA, INC. 460 HORIZON DRIVE SUITE 400 SUWANNE, GA 30024 770-614-6101 INFO@OMIX-ADA.COM

Jeep®, Wrangler®, Cherokee®, Grand Cherokee®, JK®, TJ®, YJ®, CJ®, Jeep grille design and other names used in this catalog are registered trademarks of Chrysler LLC. Omix-ADA, Inc. or its licensees are not affiliated with Chrysler LLC. All parts listed are aftermarket replacement parts. Part numbers, illustrations and images used for reference purpose only. No implication is made that these are original equipment parts, from those sources whose part numbers are used here for reference or that they are approved by those companies. Omix-ADA®, Rugged Ridge®, Outland Automotive®, Alloy USA® and Precision Gear® names and logos are registered trademarks of Omix-ADA, Inc.®